

FRAMAR CUTTERS LTD

Quality metal cutters for the icing trade



CATALOGUE

2013

19B MOOR ROAD, BROADSTONE, DORSET, BH12 8AZ

TEL: 01202 659760

FAX: 01202 659133

EMAIL: FRAMAR@HOTMAIL.CO.UK

WWW.FRAMARCUTTERS.CO.UK



TERMS AND CONDITIONS

We have the pleasure in presenting our latest catalogue of metal cutters for use by both Sugar Crafters and Cold Porcelain artists. Our cutters are made from the finest quality Tine plated steel, and are bound by non-toxic solder to ensure no contaminations passed to your sugar products.

New Accounts

To open a trading account we will require a Bank and two trade references. To ensure your initial orders are not delayed, we recommend you place your first order over the phone

To Order

You can order either by Fax or letter, or by contacting us via our website, framarcustters.co.uk. Please quote the item name and our code clearly on your order.

Prices and Payment

All of our prices are quoted in £ sterling and payment must be made in the same manner. If you pay in alternative currency you may be liable for bank charges and exchange rate fluctuation costs.

Payment is required strictly 30 days from the date of invoice; **please refer to our price list for early payment and volume discount rates.**

The title of goods will remain the property of Framar Cutters until payment is received in full.

There is a 10% discount on all orders over £100

Carriage and Packing

All mainland UK as follows:

<u>Order value after discount</u>	<u>Charges</u>
Up to £100.00	£3.00
£100.01 to £250.00	£5.00
Above £250.00	£8.00

All other destinations will be charged at cost

The above are subject to change without prior notification

Delivery

We aim to dispatch orders of our standard range of cutter within 5 working days from receipt of order; however this may be longer during busy periods. Delivery of special designs will be confirmed on receipt of order.

Returned Goods

Returned goods will only be accepted providing we have been notified of the defect and agree to accept liability. These goods must be packaged correctly and marked fragile

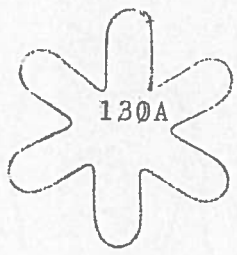

130A



130B

AGAPANTHUS

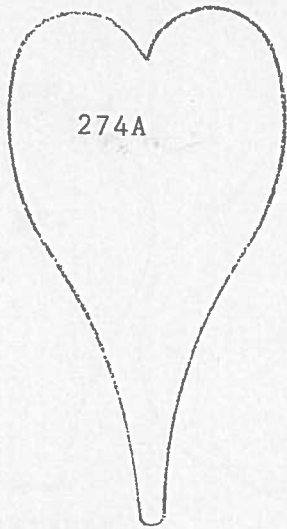

274A

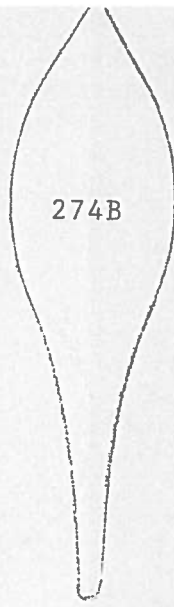

274B

ALSTROEMARIA

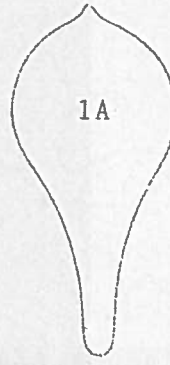

1A

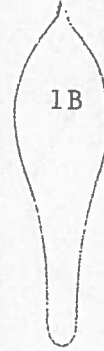

1B

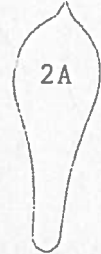

2A

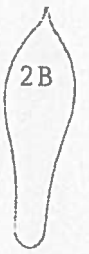

2B

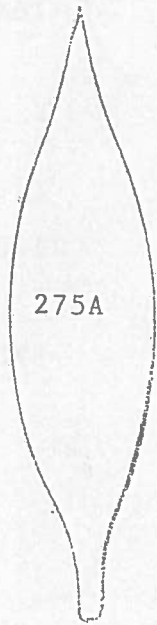

275A



275B

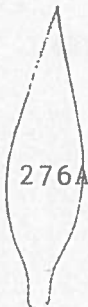

276A

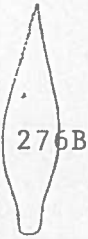

276B

ALSTROEMARIA LEAF



277A

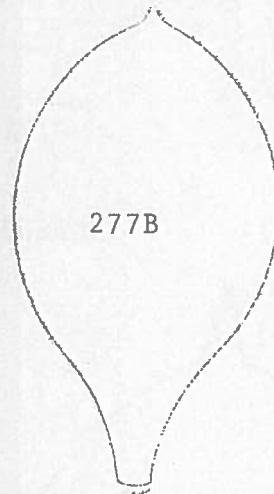

277B

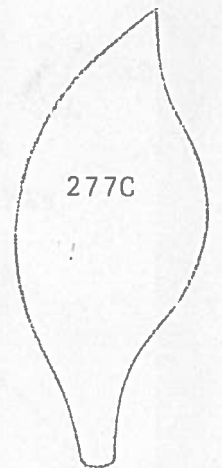

277C

AMARYLLIS

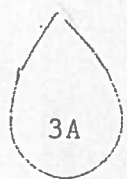

3A

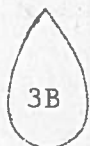

3B

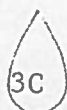

3C

ANEMONE

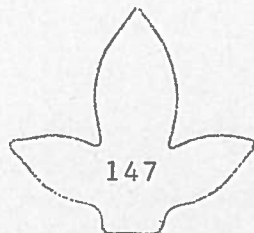

147

ANEMONE LEAF

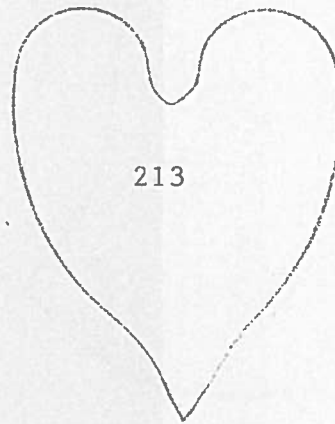

213

ANTHURIUM

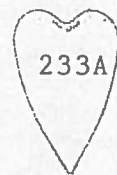

233A



233B

ANTIRRINUM



APPLE BLOSSOM

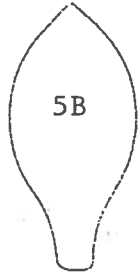

AZALEA

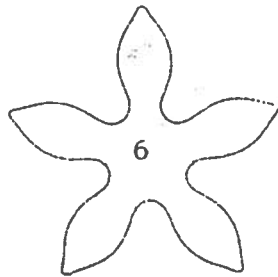
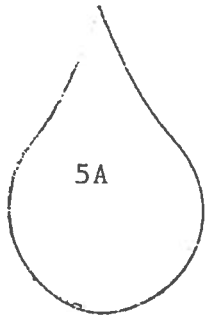

KARUME AZALEA

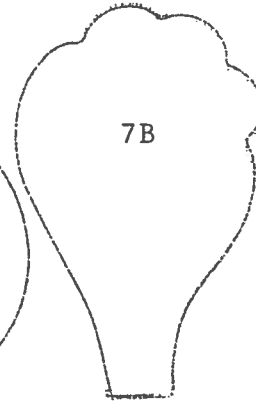
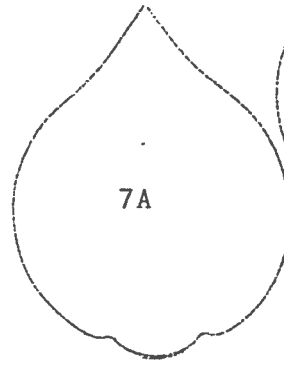

BAUHINIA

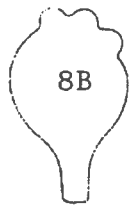
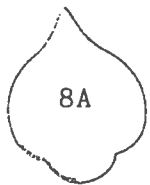
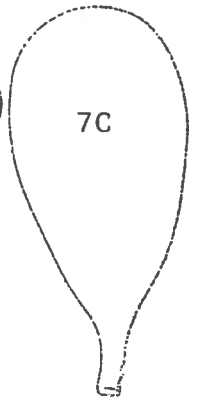

BAUHINIA

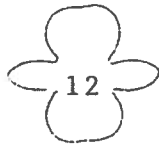
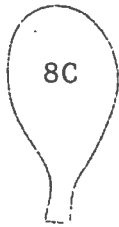

BEGONIA

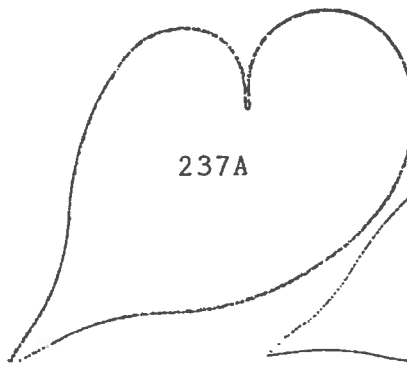

BEGONIA LEAF



116A



116B

BELL

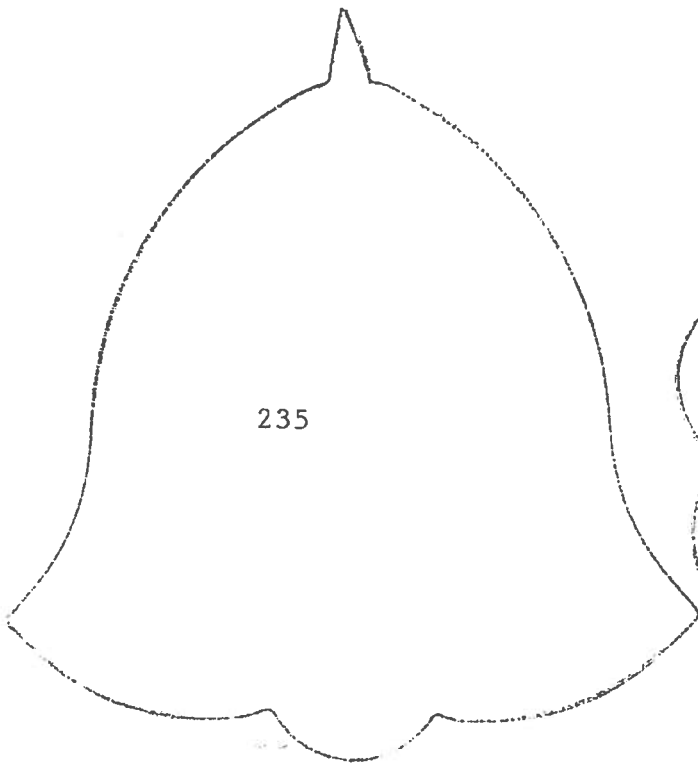

BELL

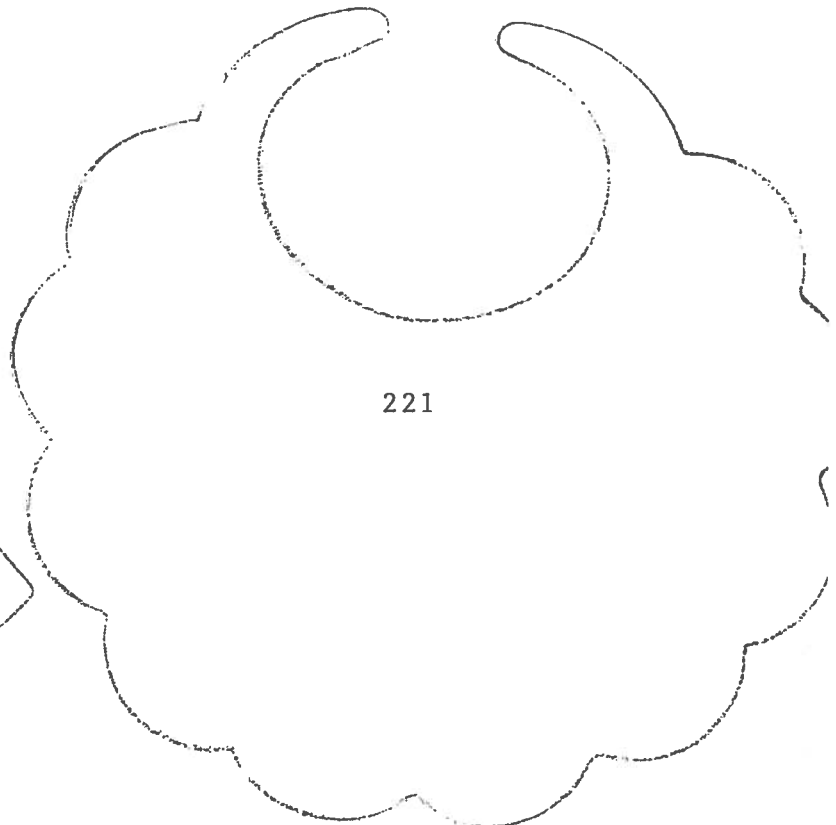

221

BIB

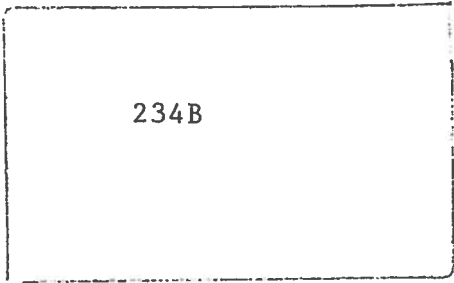

234B

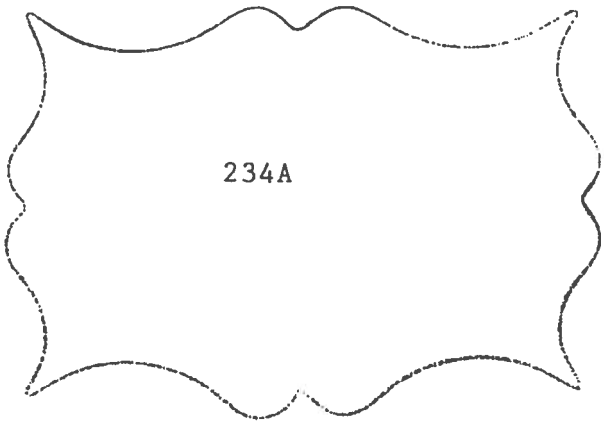

234A

BIBLE

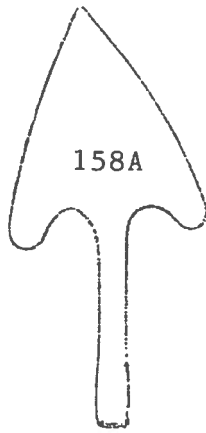

158A



158B

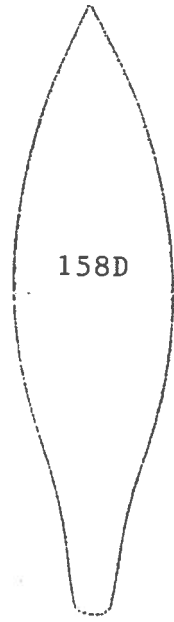

158D

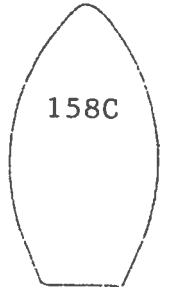

158C

BIRD OF PARADISE

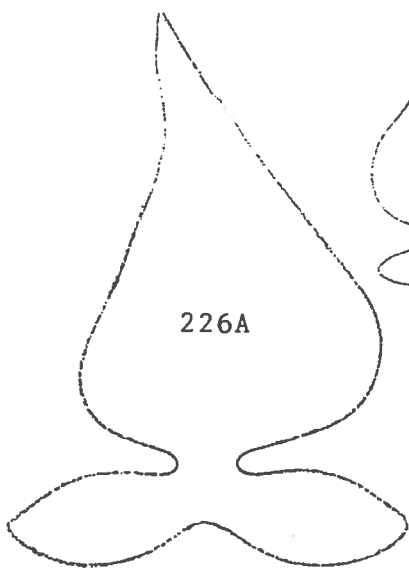

226A

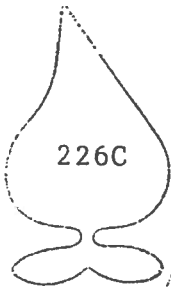

226C

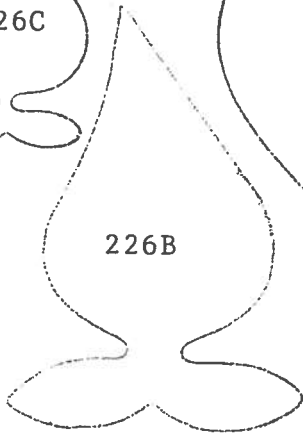

226B

BITTERSWEET

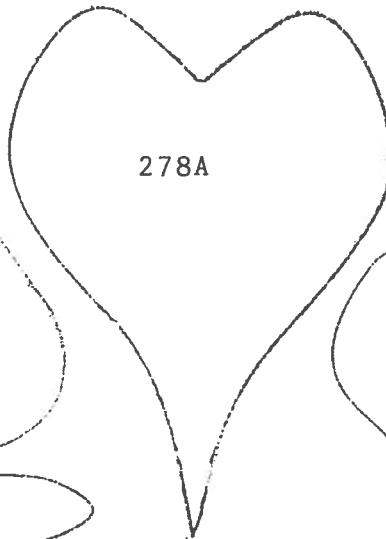

278A

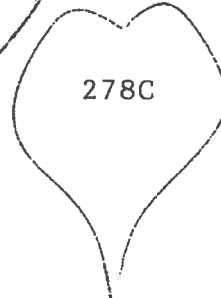

278C

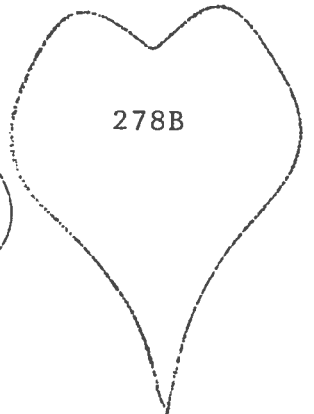

278B

BLACK BRIONY

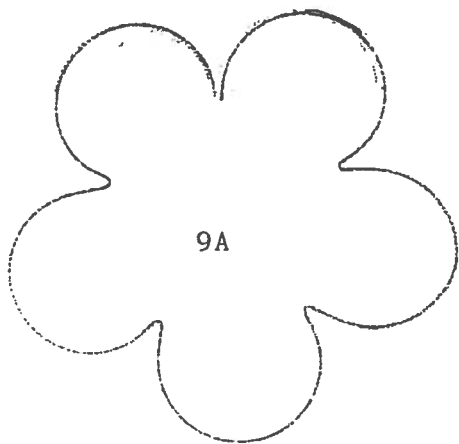

9A

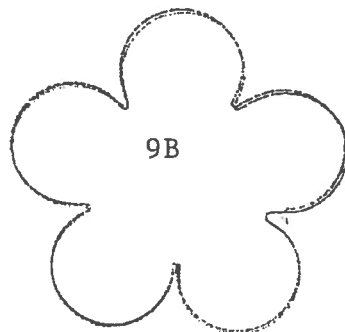

9B

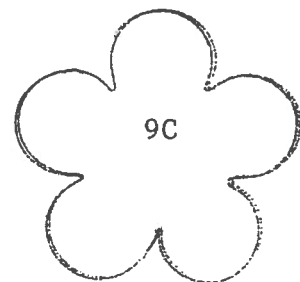

9C

BOSSOM

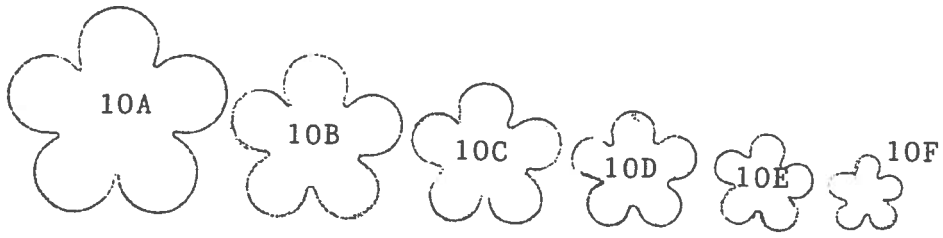

BLOSSOM

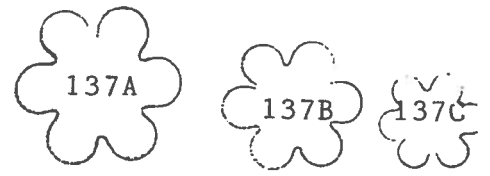

6 LOBED BLOSSOM

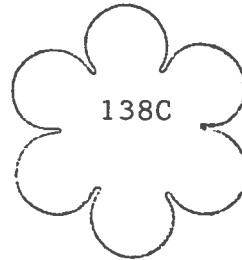
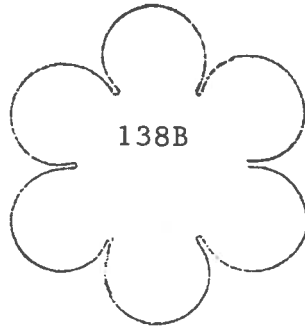
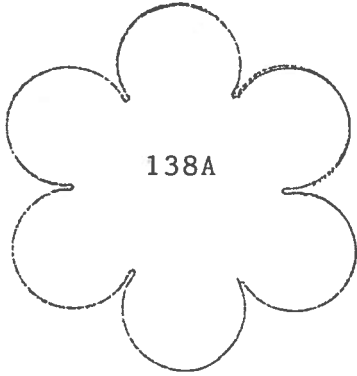

6 LOBED BLOSSOM



BLUEBELL

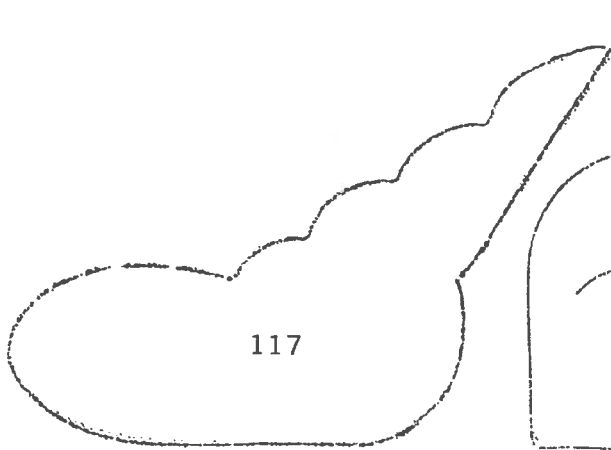

BOOTEE

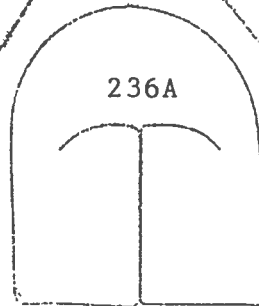

BOOTEE

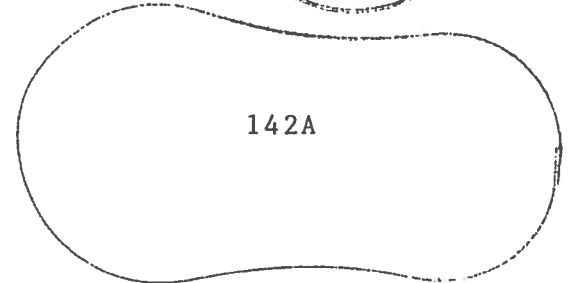
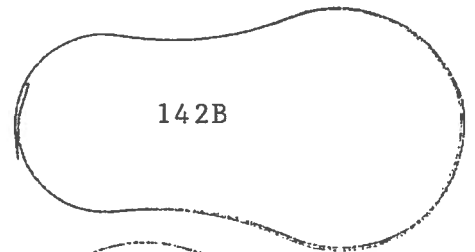

BOOTEE SOLE



BORONIA

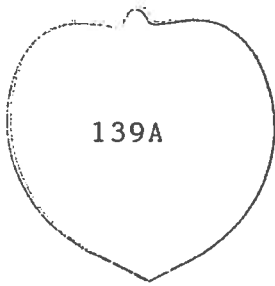

BOUGAINVILLEA



BOW



BROWALIA

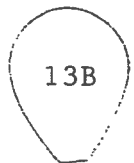

BUTTERCUP

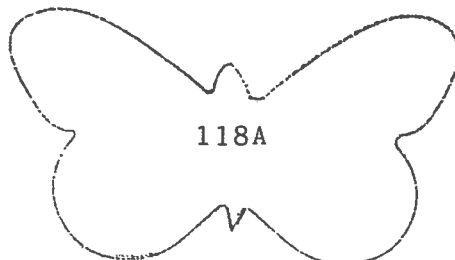
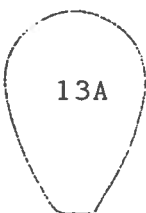

4

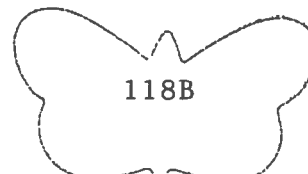

BUTTERFLY



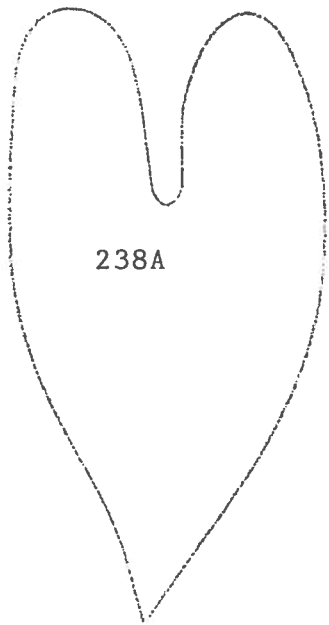

238A

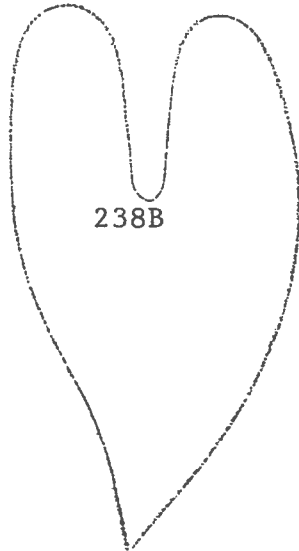

238B

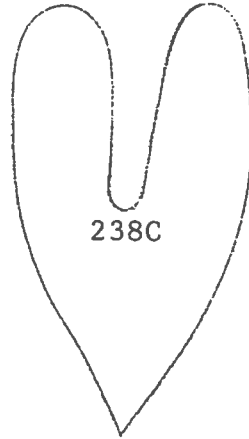

238C

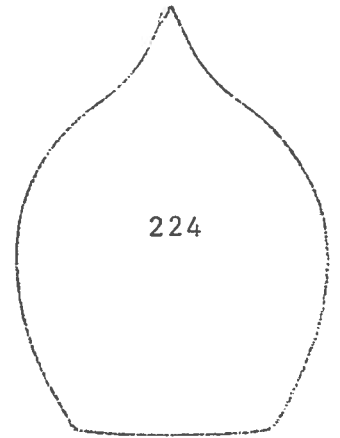

224

CALADIUM LEAF

CANNA LEAF

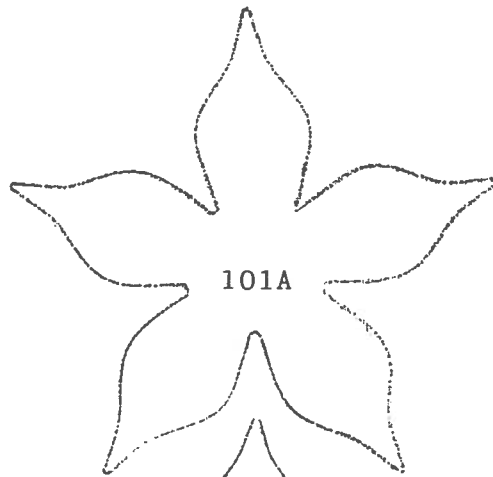

101A

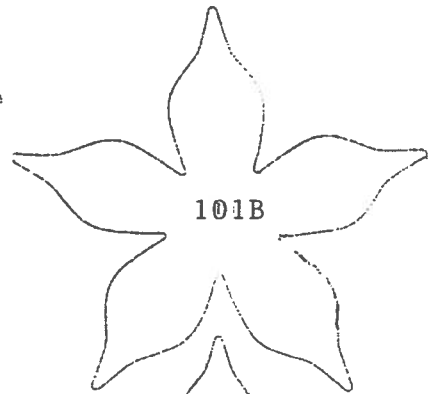

101B

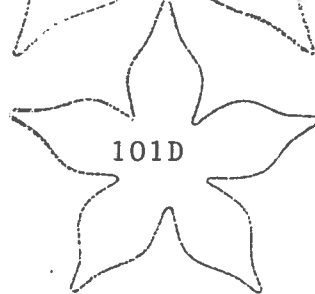

101D

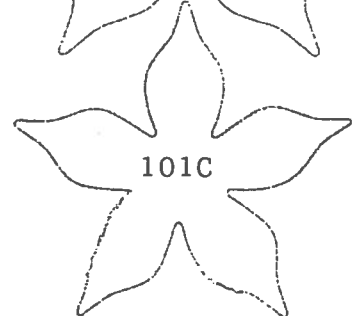

101C

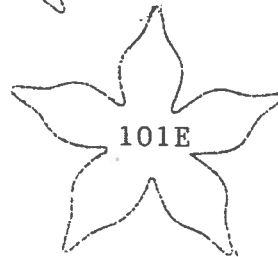

101E



101F

ROSE CALYX



15

CALYX



16

CALYX



16A

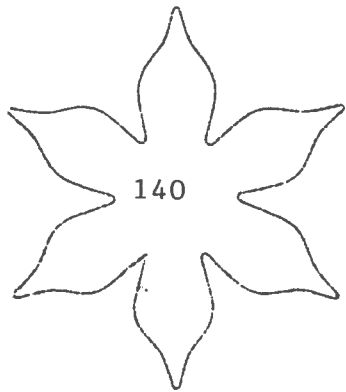

140

SIX POINTED CALYX

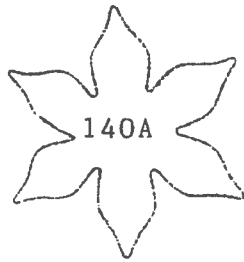

140A



17A

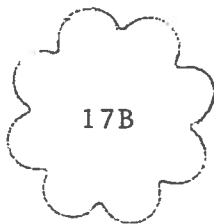

17B

CARNATION



17C



17D

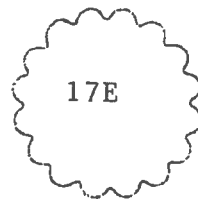

17E

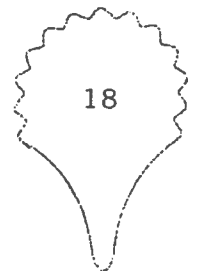

18

CARNATION/
SCABIUS

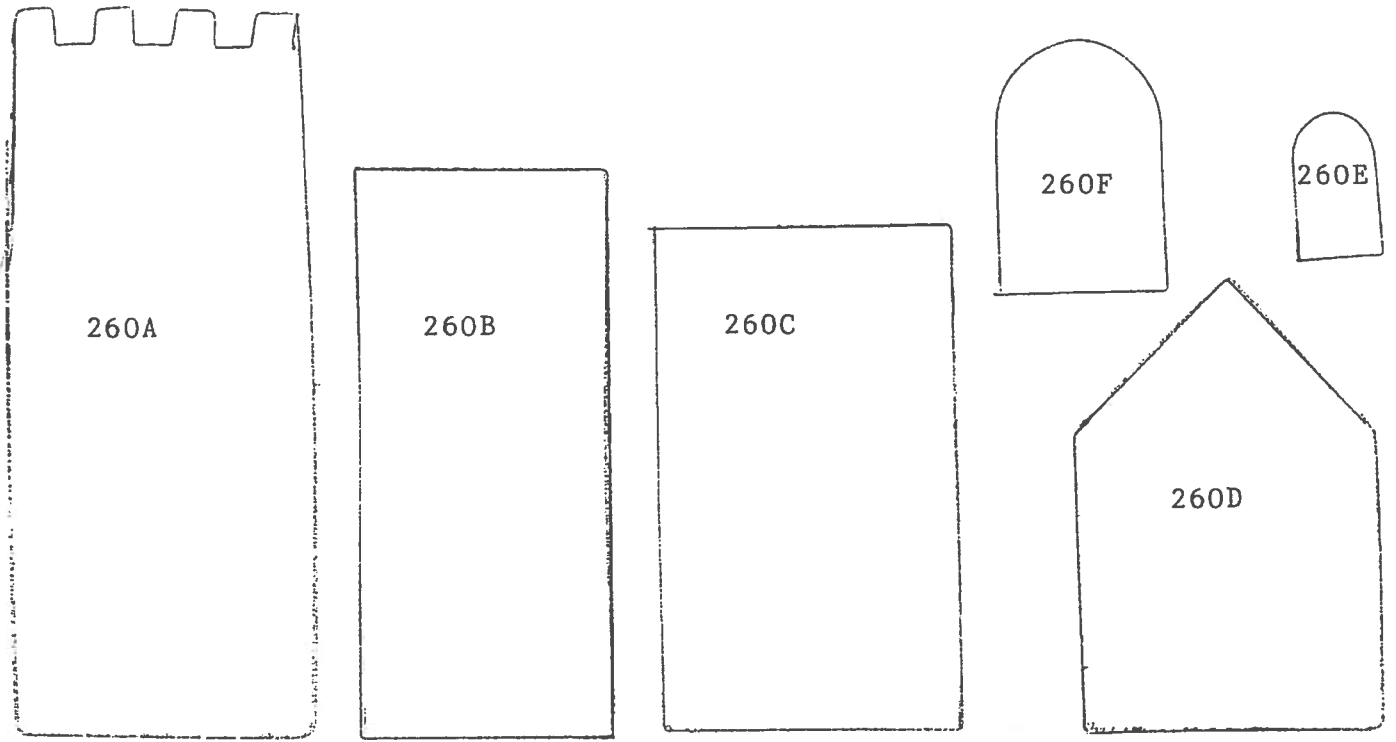

CHURCH

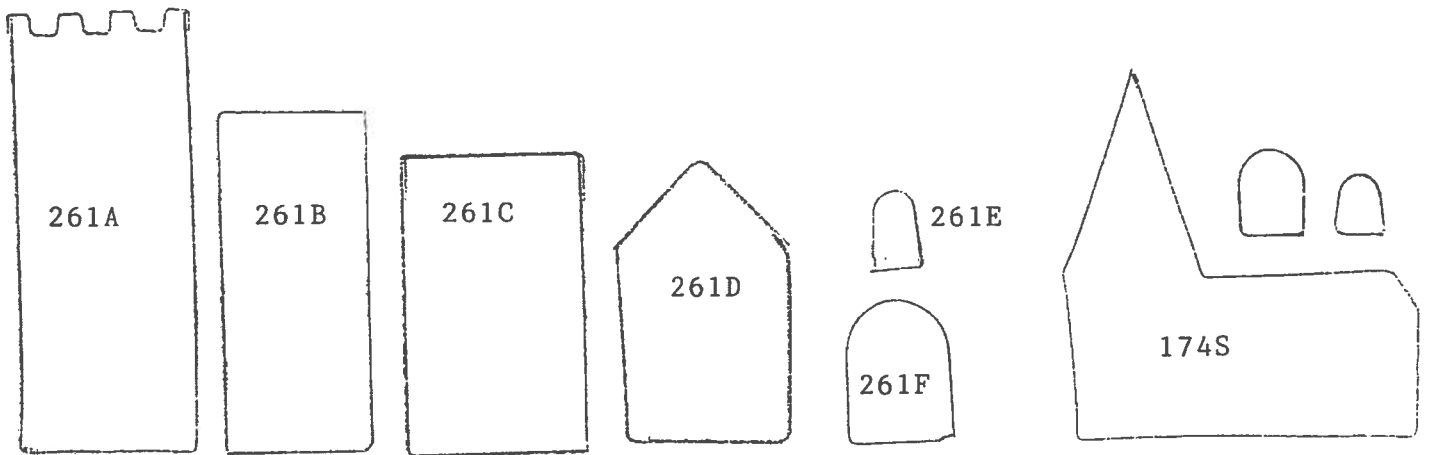

CHURCH

CHURCH

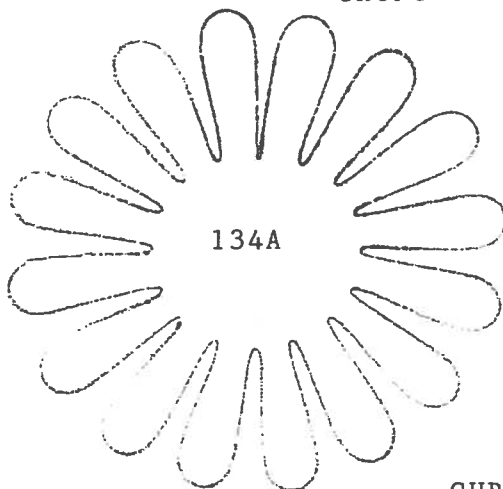

CHRYSANTHEMUM

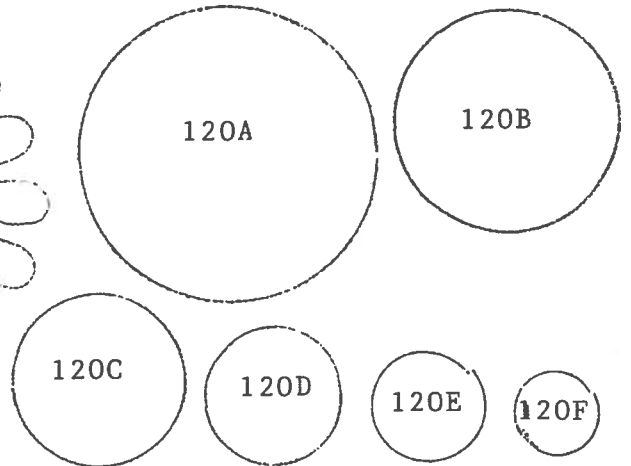
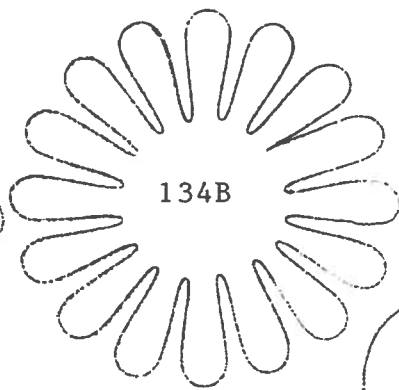

CIRCLE

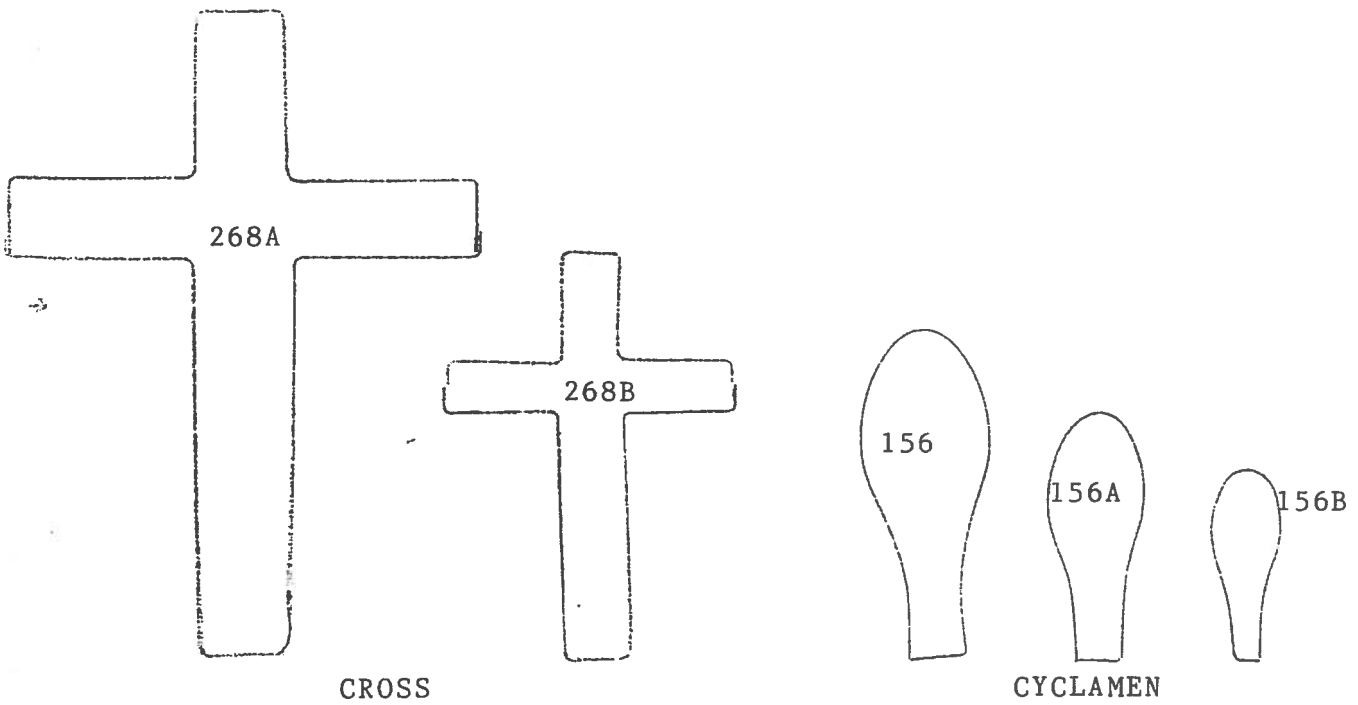
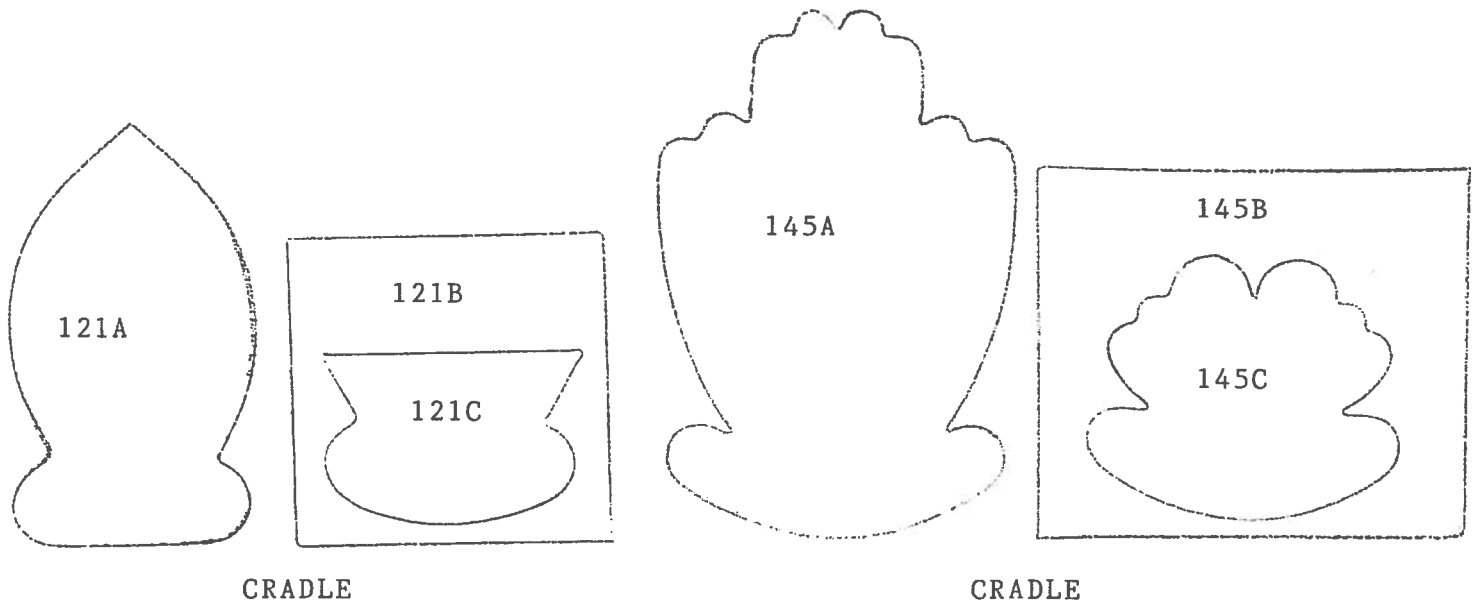
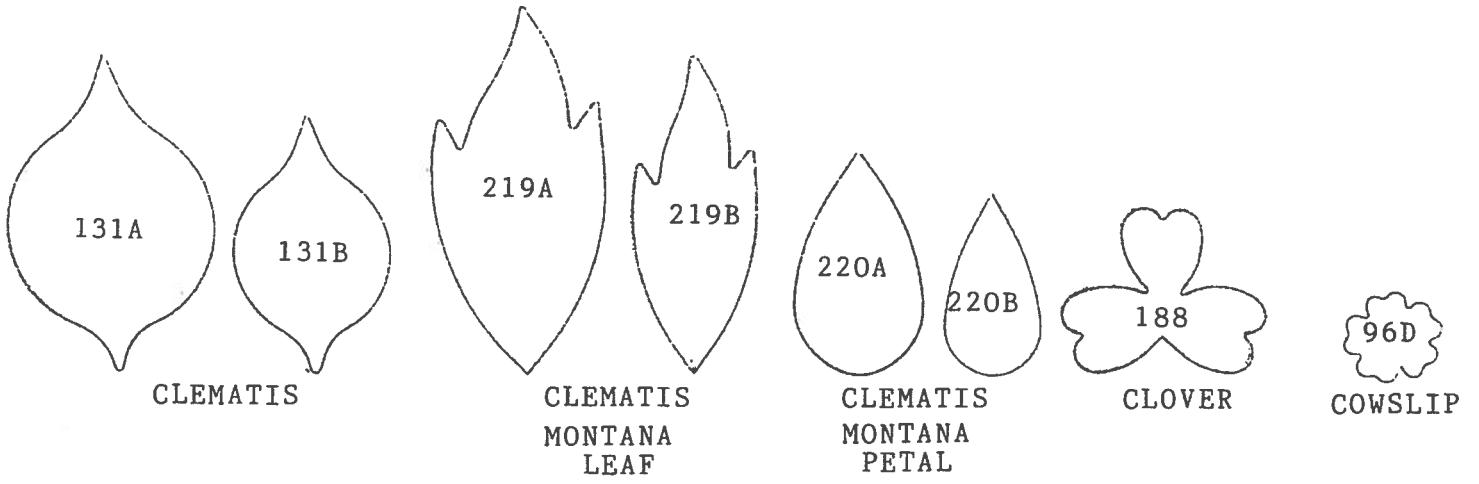

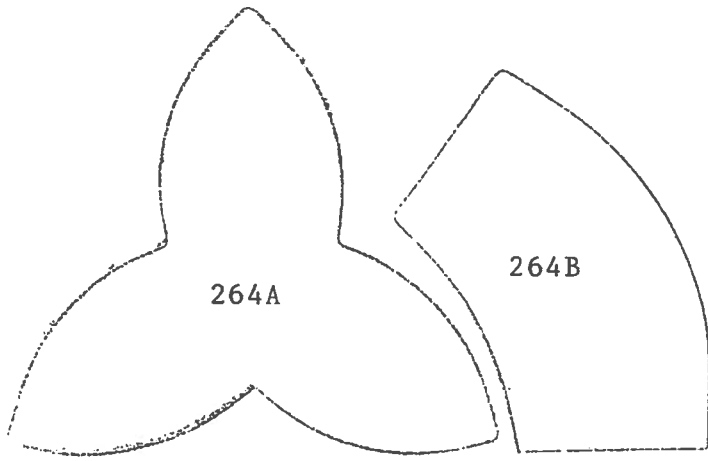

DAFFODIL

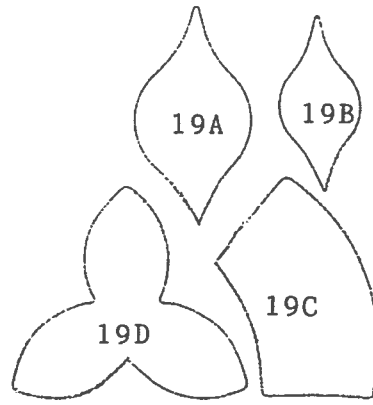

DAFFODIL

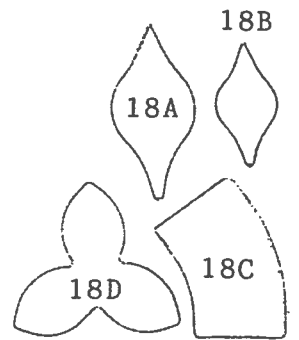

DAFFODIL



DAFFODIL

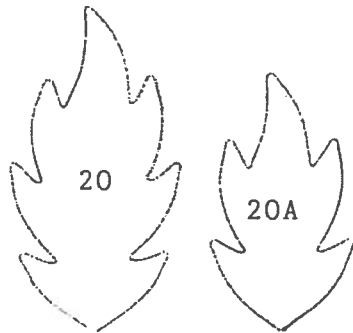

DAISY LEAF

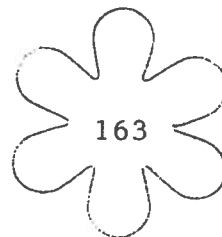

COREOPSIS
DAISY

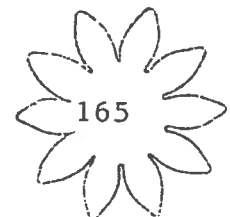

TEN PETAL
DAISY

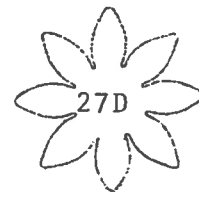
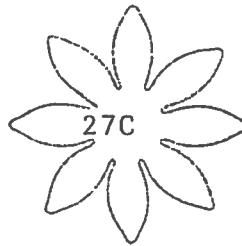
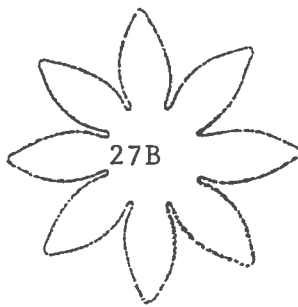

EIGHT PETAL DAISY

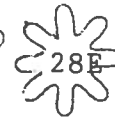
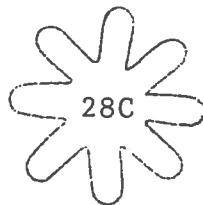
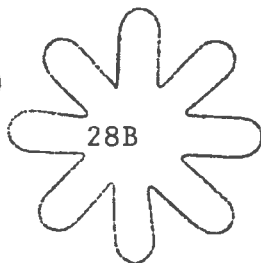
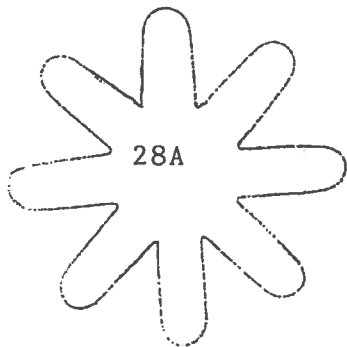

EIGHT PETAL DAISY

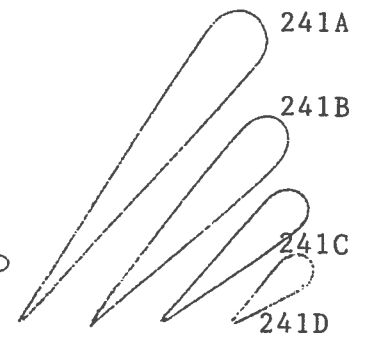

DAISY PETAL



DAPHNE

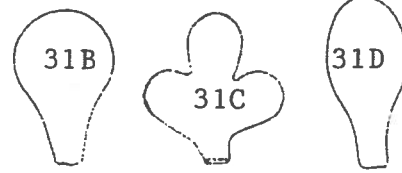
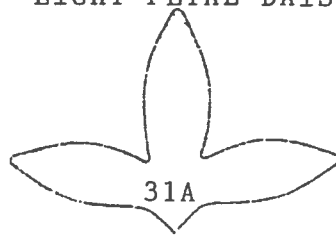

DENDROBIUM

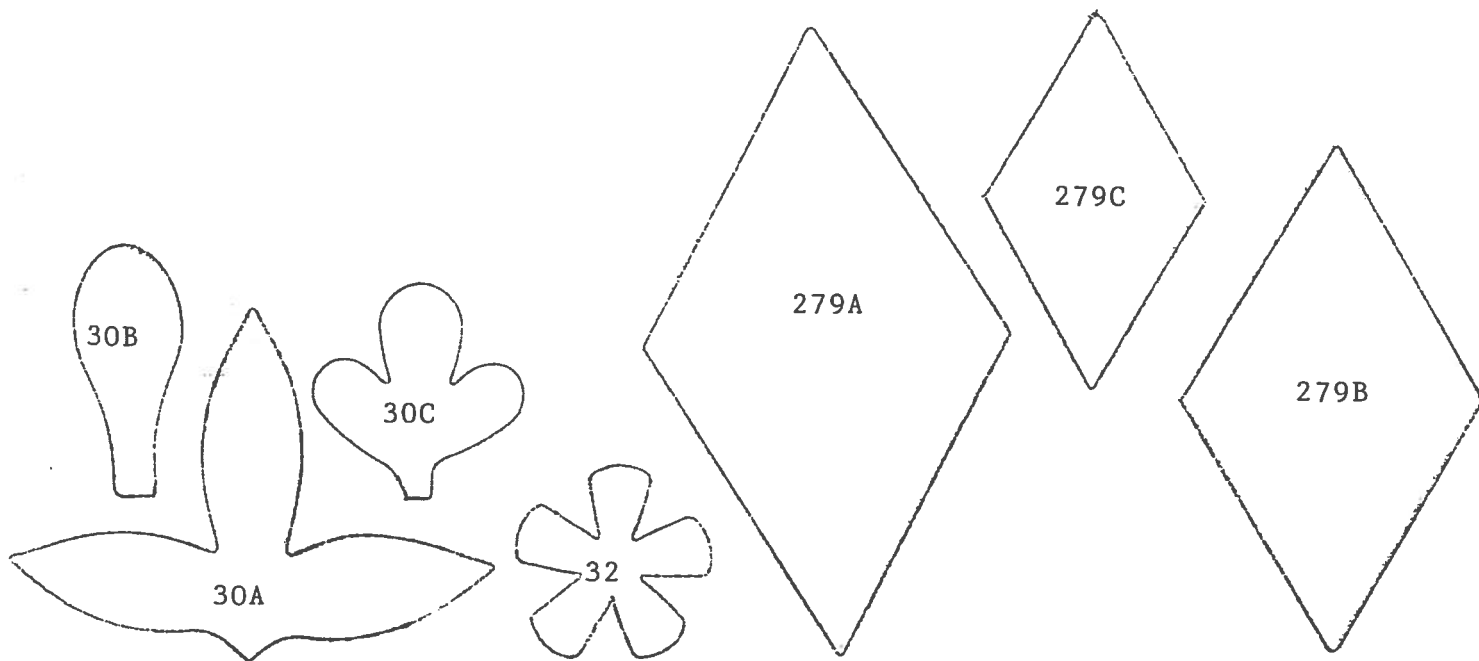

DENDROBIUM

DIANTHUS

DIAMOND

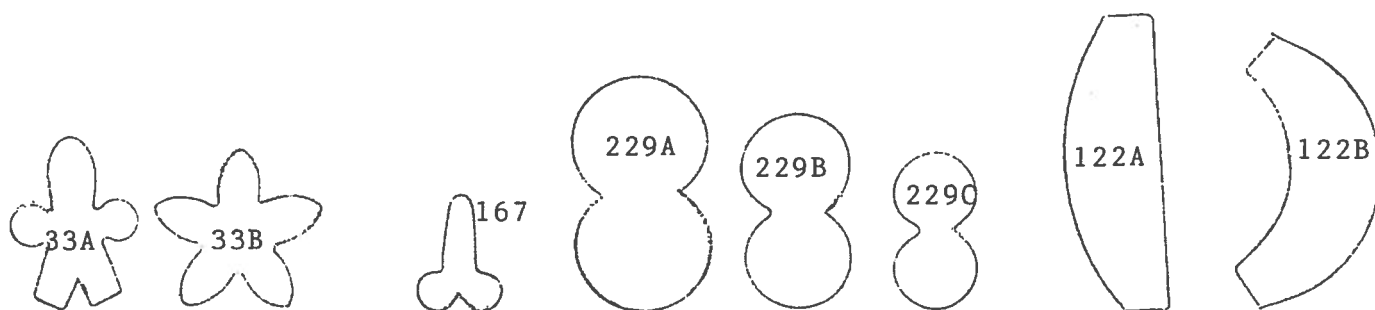

EPIDENDRUM

ESCALONIA

EUCALYPTUS

EXTENSION CUTTER

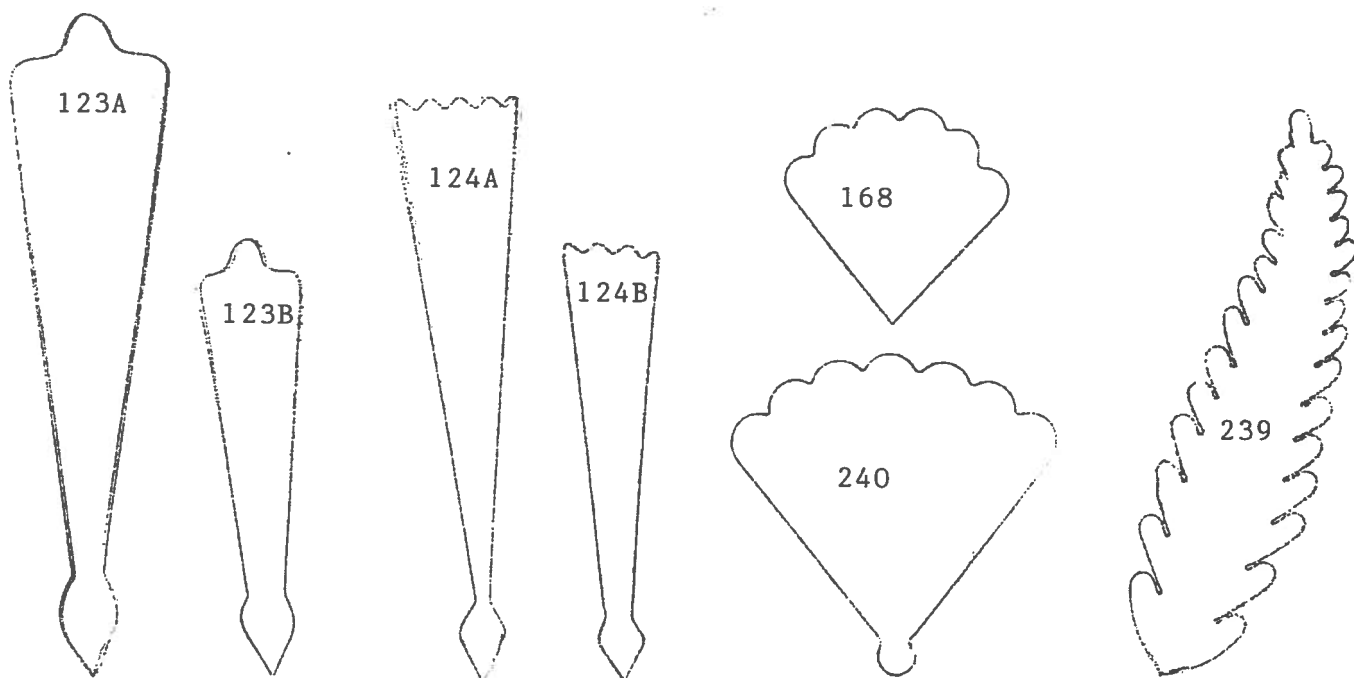

FAN

FAN

FAN

FERN

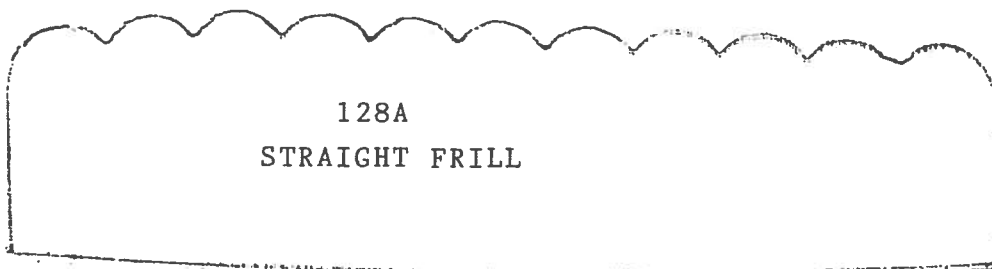
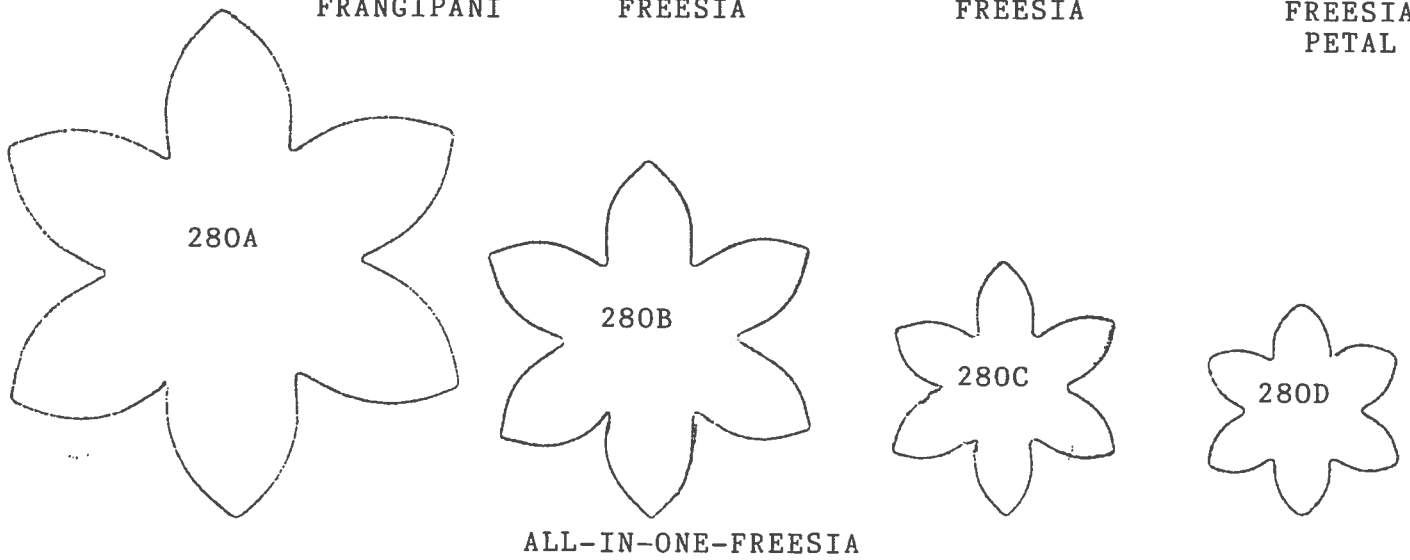
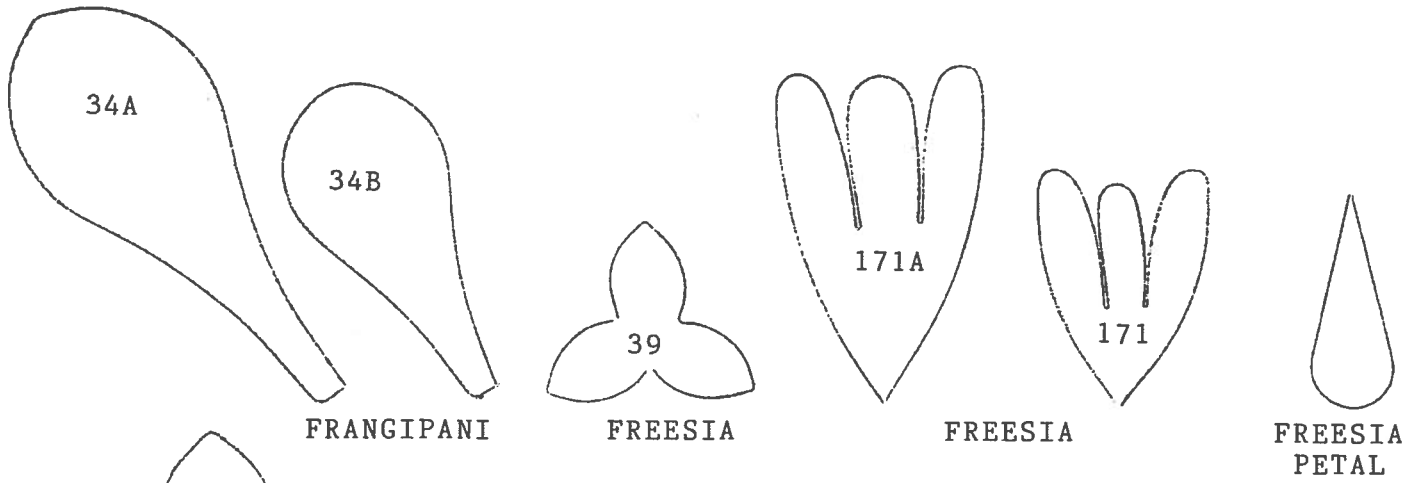
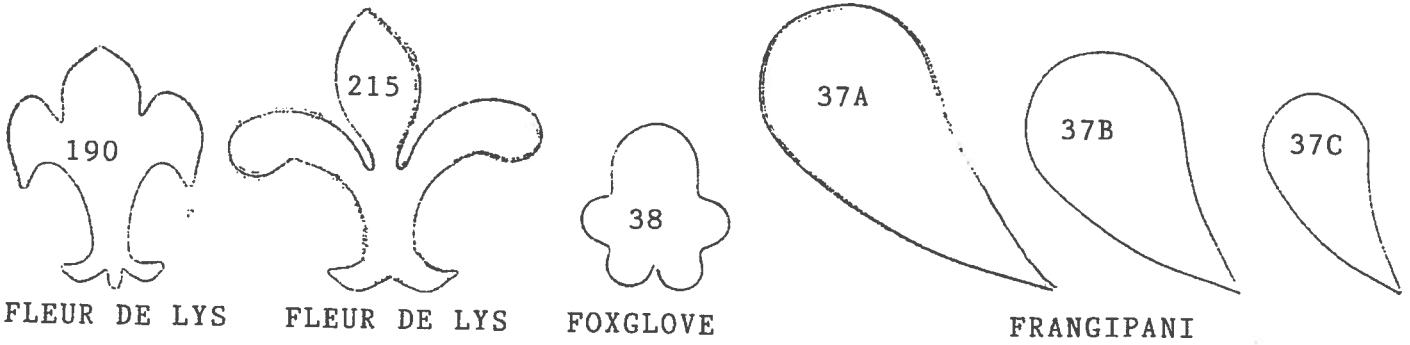

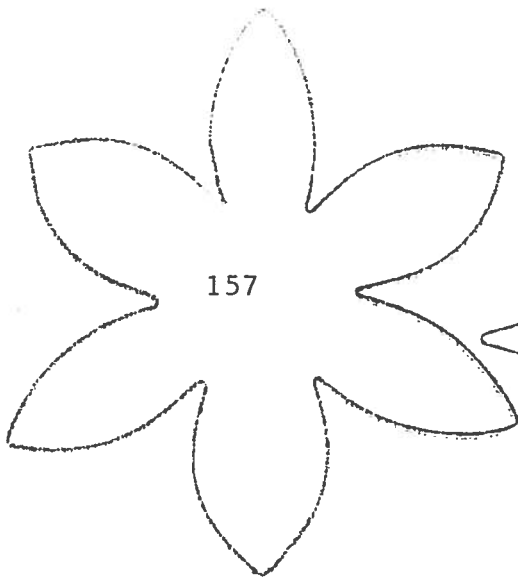

FRITILLARIA

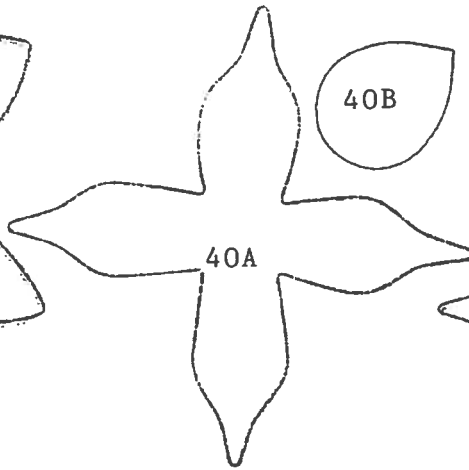

FUCHSIA

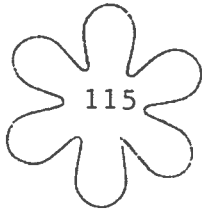
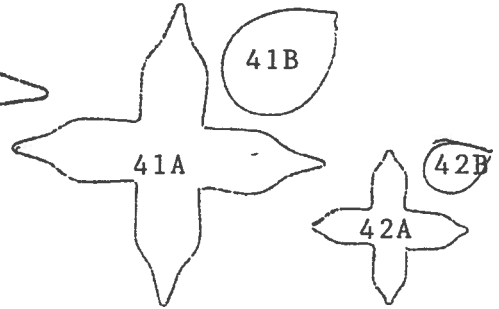

FUCHSIA SHIRT

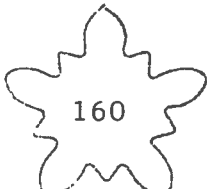

GENTIAN



GERBERA

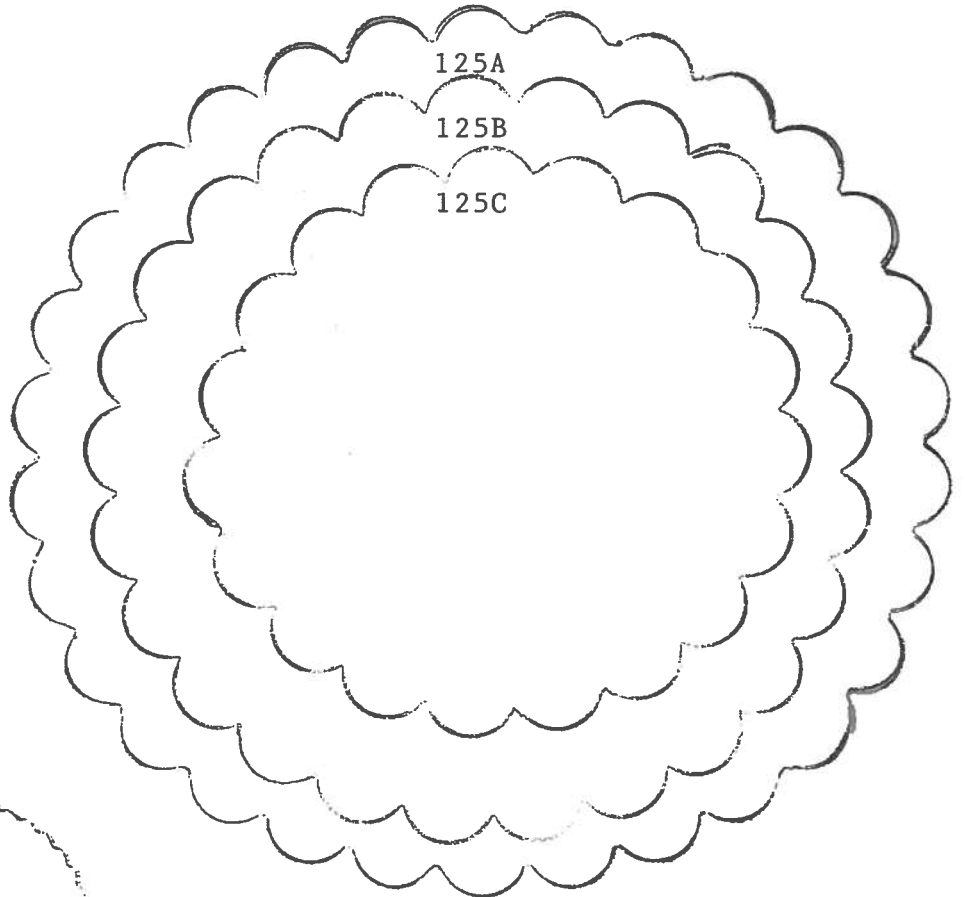

GARRET FRILL

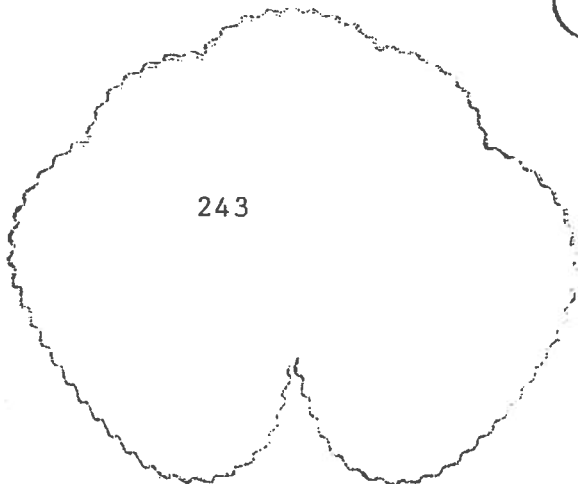

GERANIUM LEAF

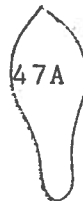

GLADIOL

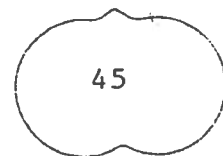

GODETIA

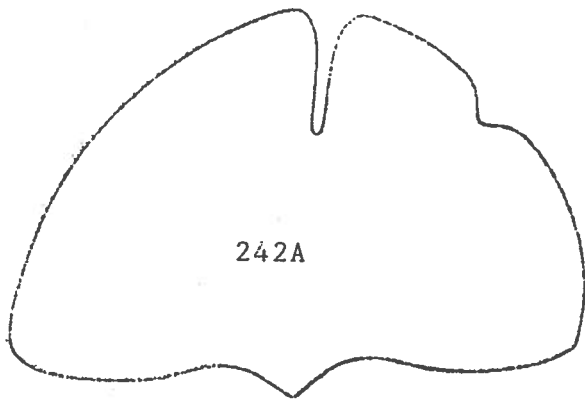

242A

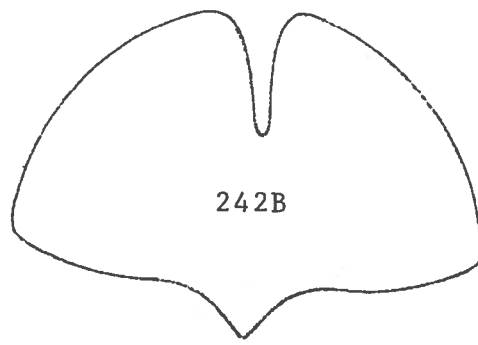

242B

GINGKO LEAF

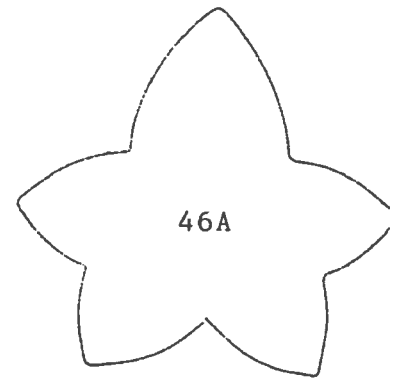

46A

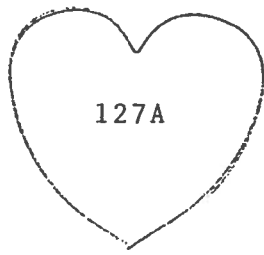

127A

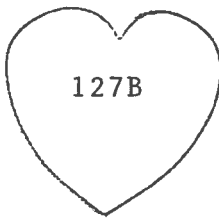

127B

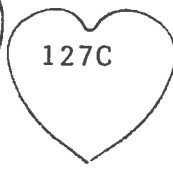

127C



127D



127E



127F



127G

HEART



46B

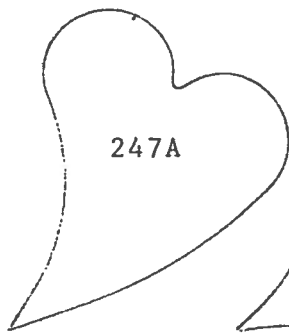

247A

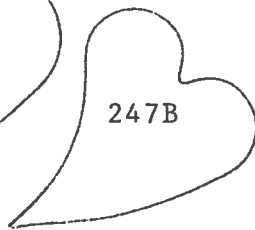

247B

HEART LEAF



148A

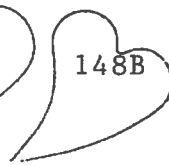

148B



148C

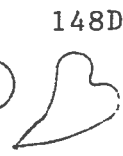

148D

HEART LEAF



46C

GRAPE LEAF

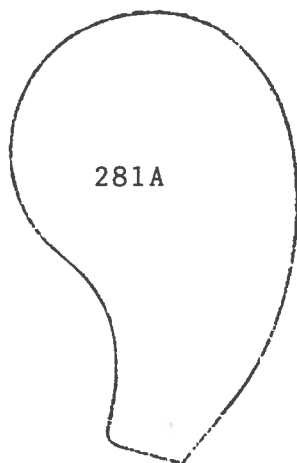

281A

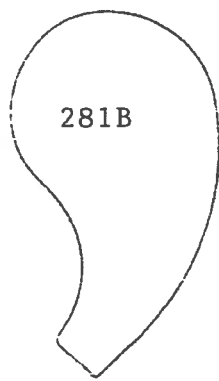

281B

HIBISCUS

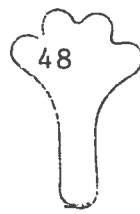

48

HONEYSUCKLE



282B

SEA HOLLY

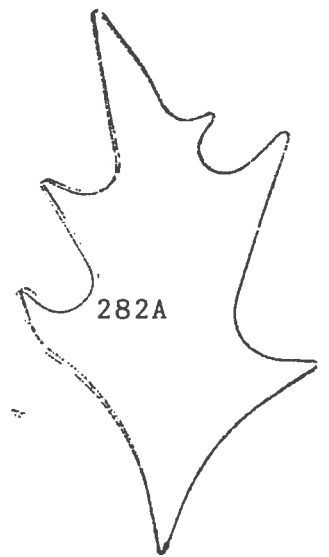

282A

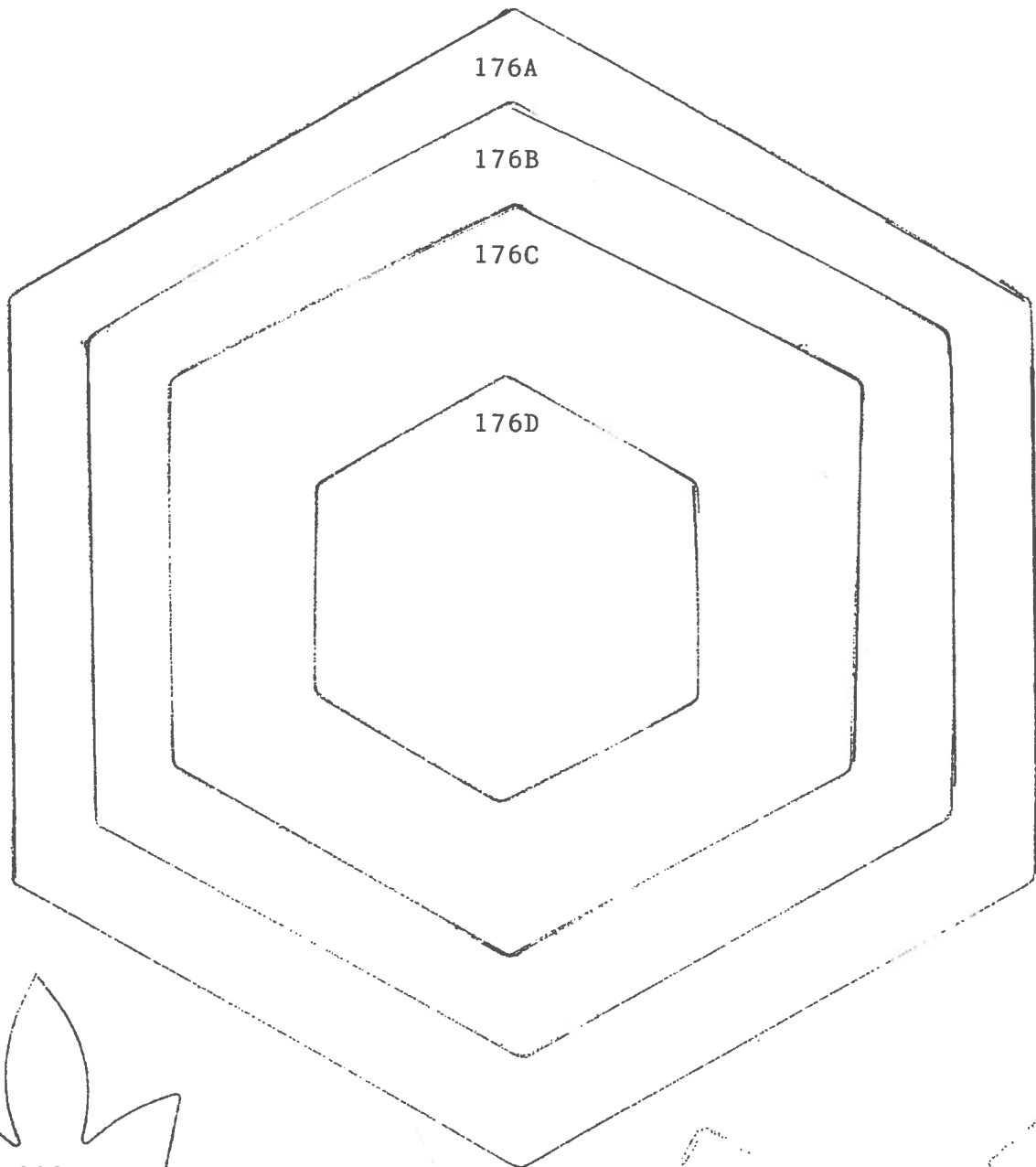

176A

176B

176C

176D

HEXAGON

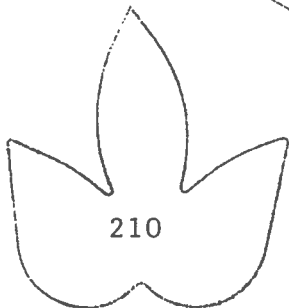

210

HOP
LEAF



248

HORSECHESTNUT
LEAF

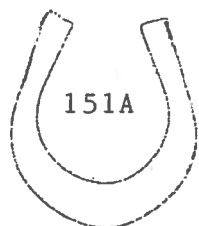

151A

HORSESHOE

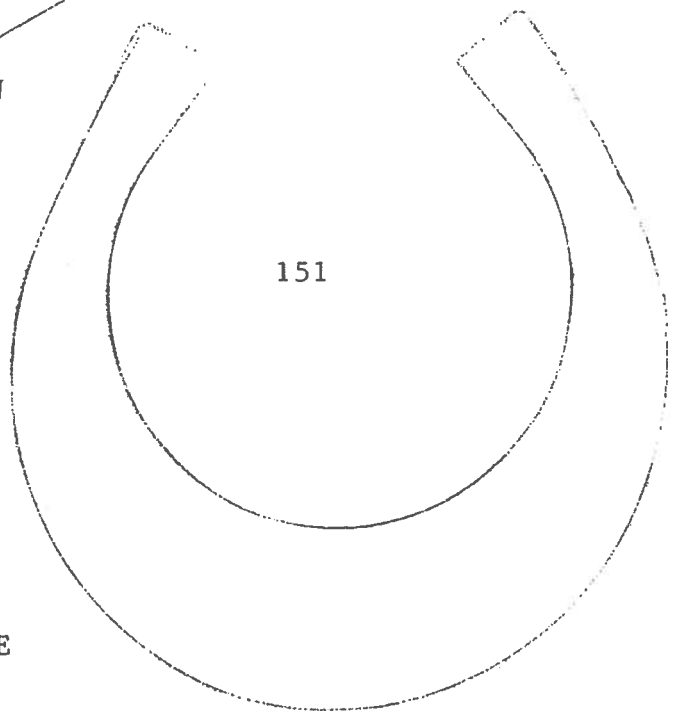

151



HYACINTH

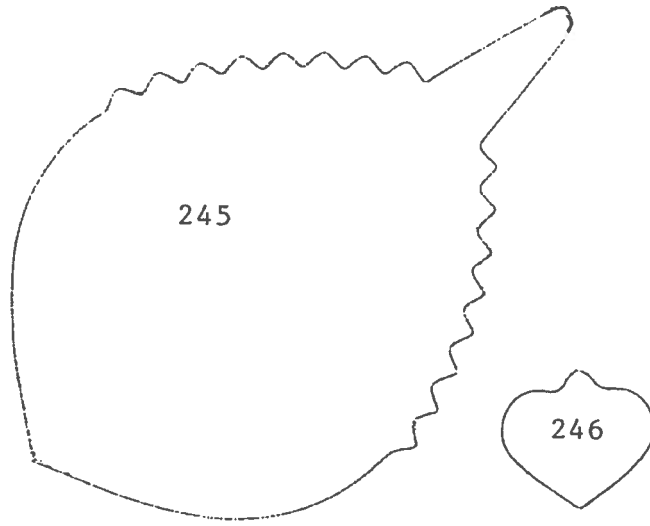

HYDRANGEA LEAF

HYDRANGEA PETAL

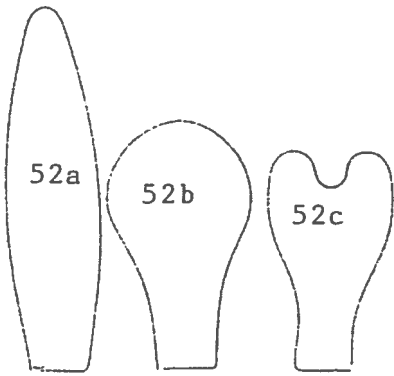

IRIS

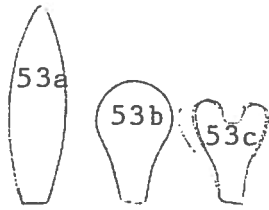

IRIS

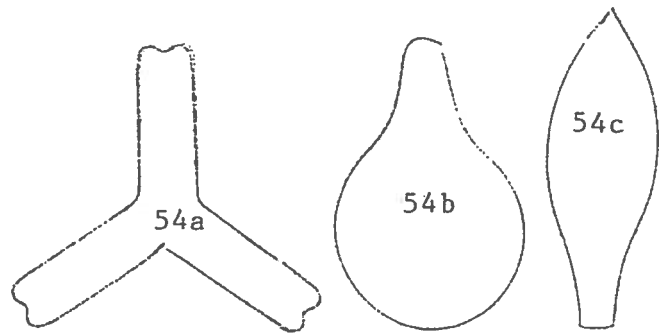

IRIS

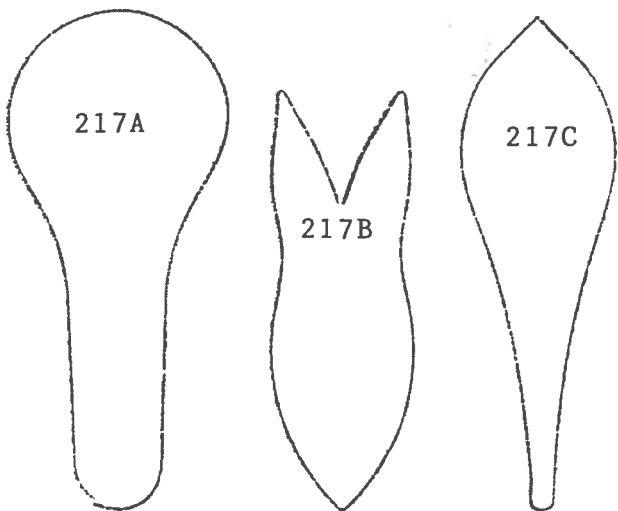

DUTCH IRIS

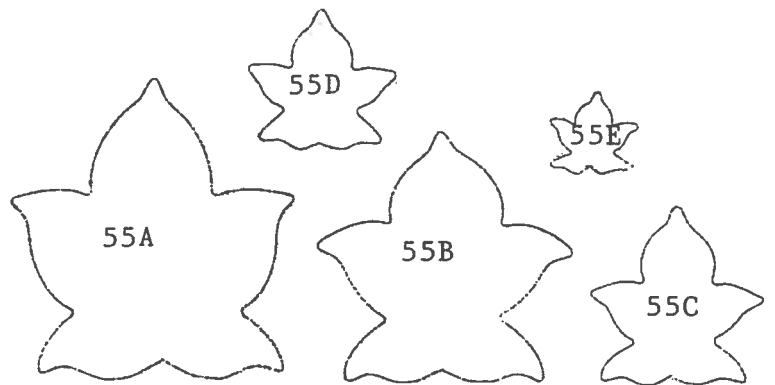

IVY

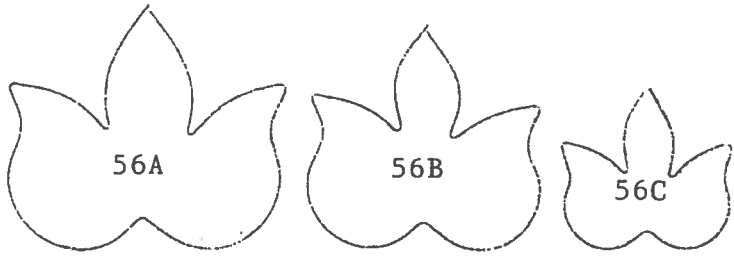

IVY LEAF

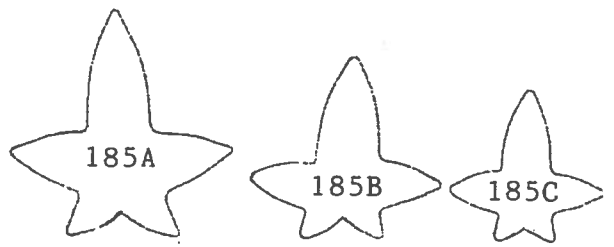

IVY LEAF



BIRDS FOOT IVY

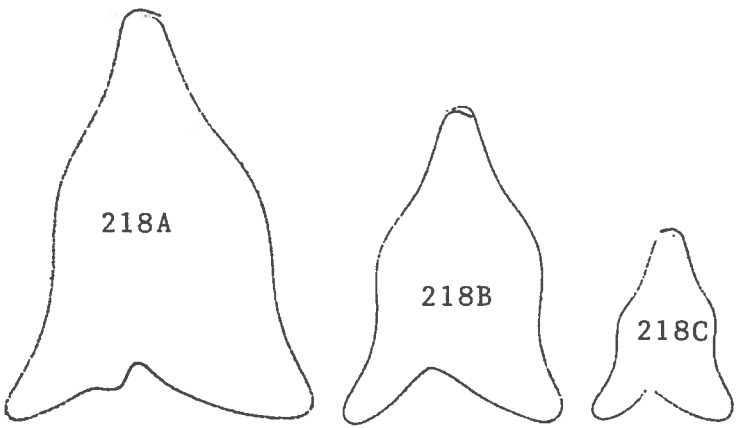

GOOSE FOOT IVY

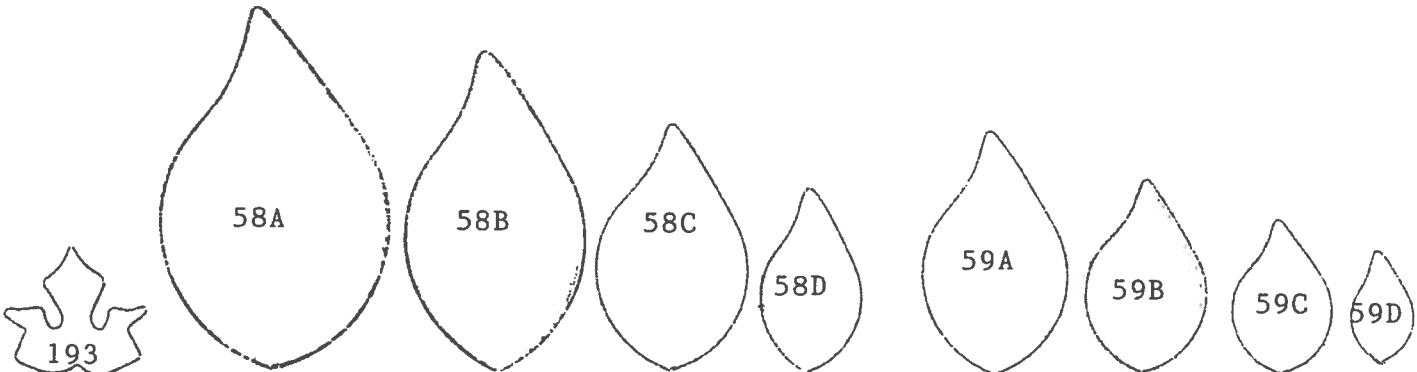

LACE

LEAF

LEAF

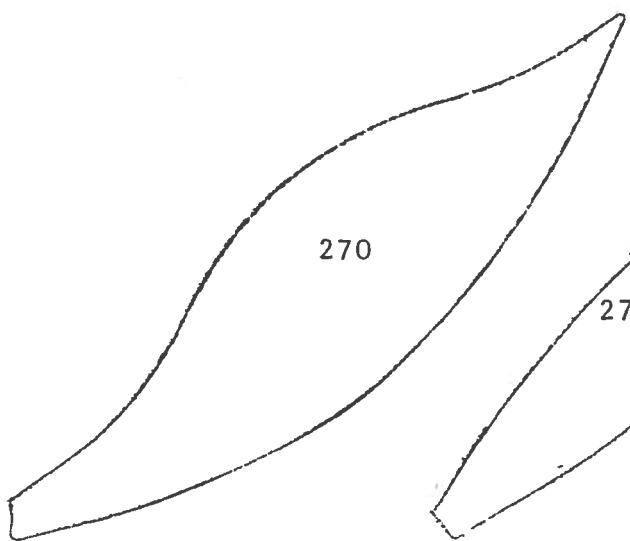

LONG LEAF

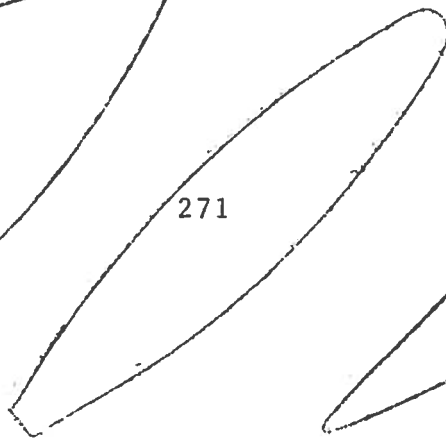

271

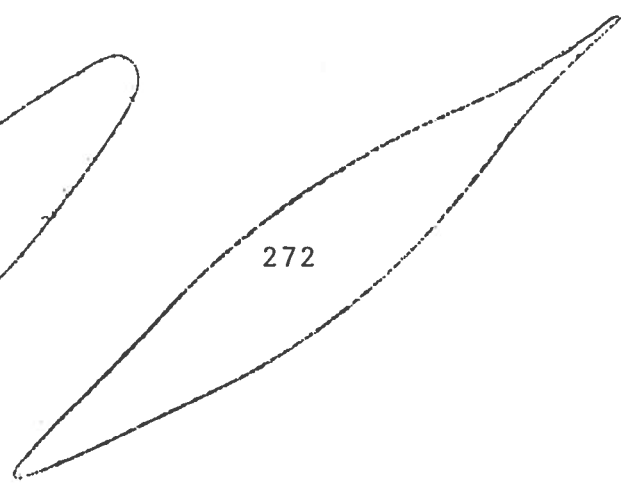

272

LILY LEAF

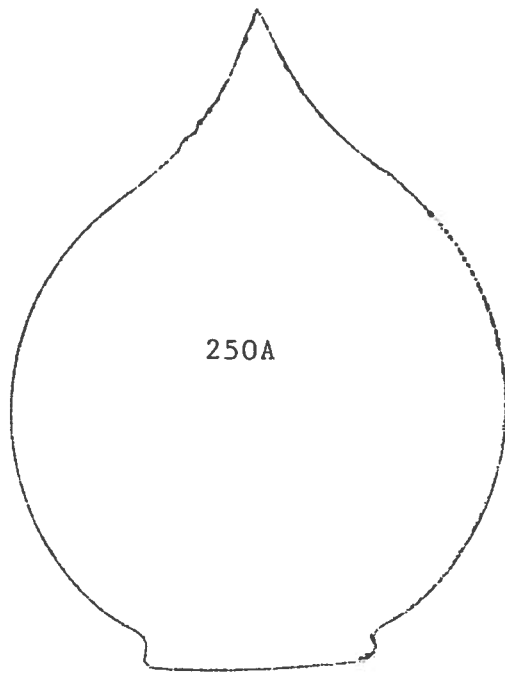

250A

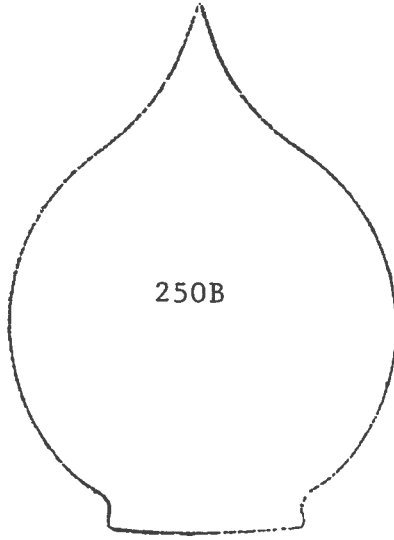

250B

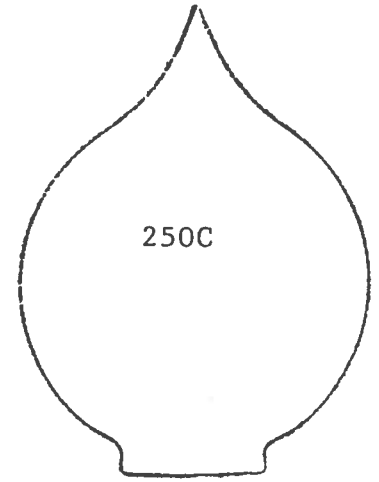

250C

ARUM LILY

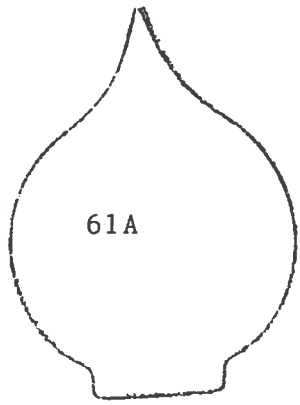

61A

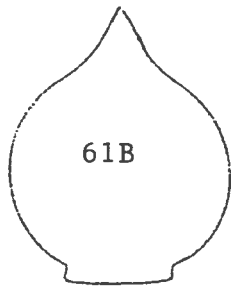

61B

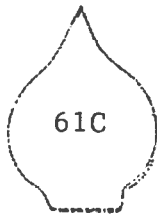

61C

ARUM LILY

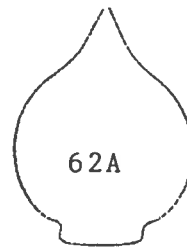

62A



62B



62C

ARUM LILY

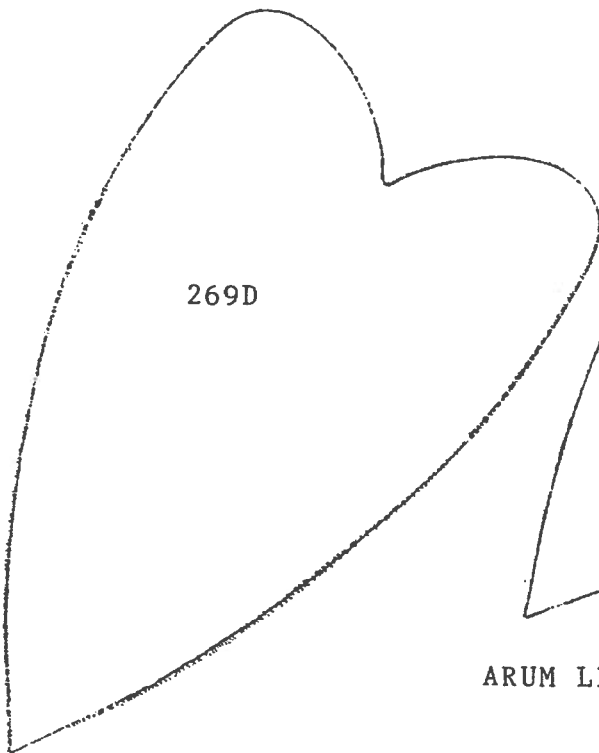

269D

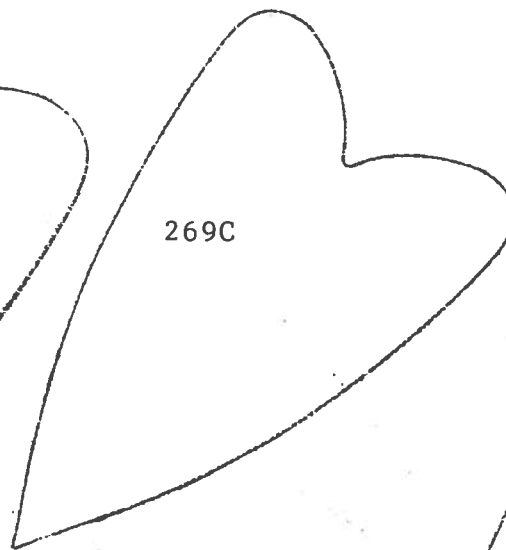

269C

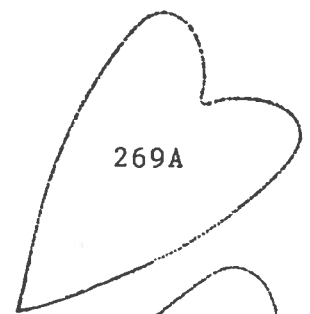

269A

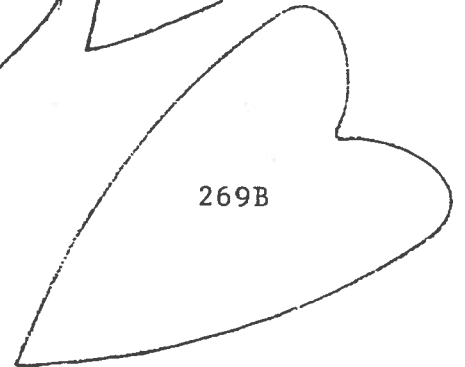

269B

ARUM LILY LEAF

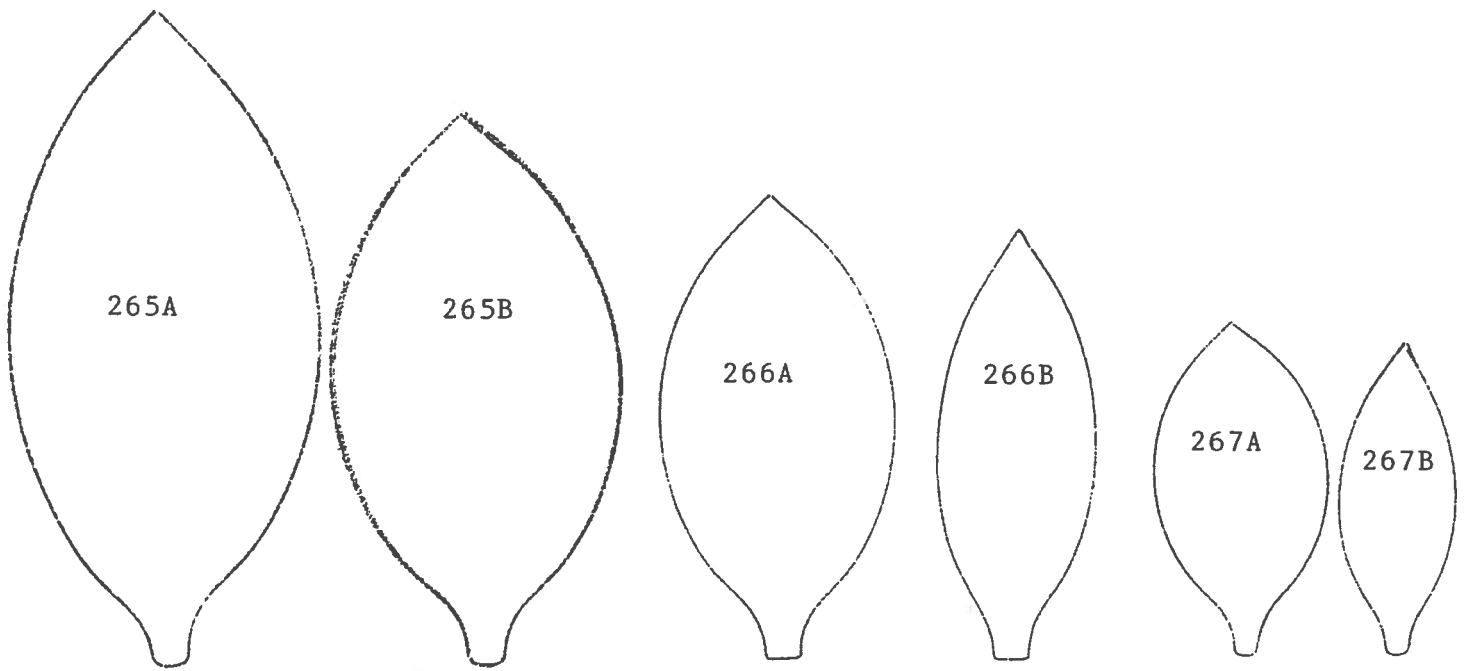

CASABLANCA/STARGAZER LILY

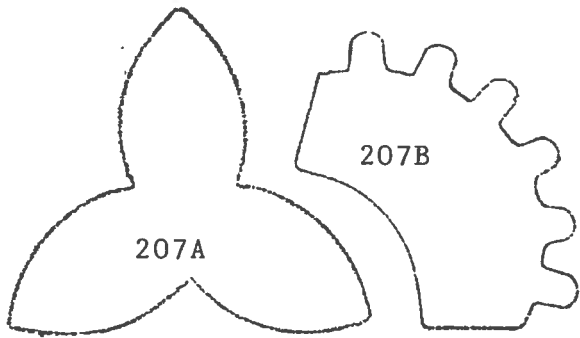

EUCHARIST LILY



FLAME LILY

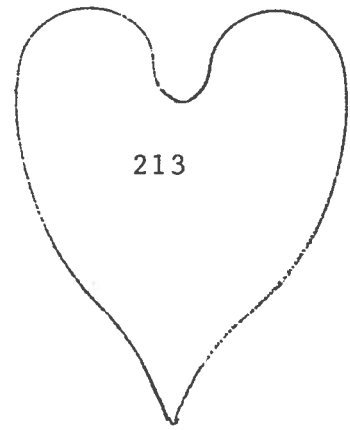

FLAMINGO LILY

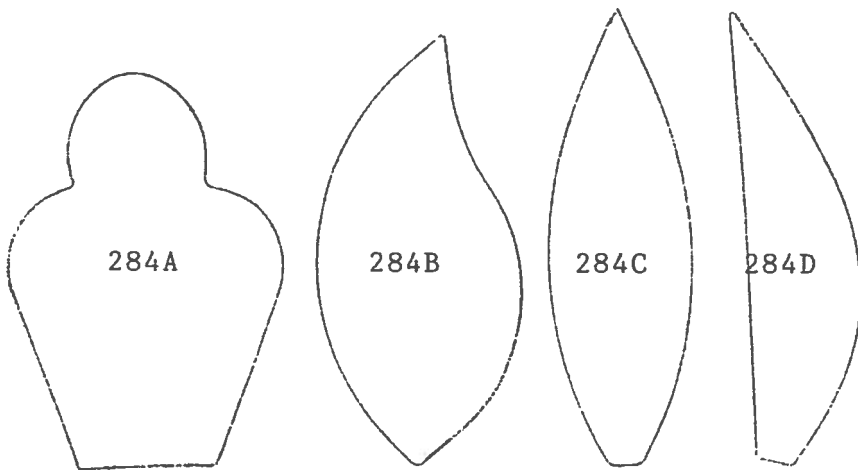

LAELIA LILY

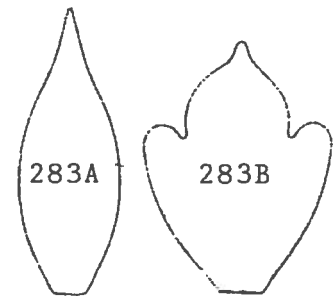

NOMOCHARIS LILY

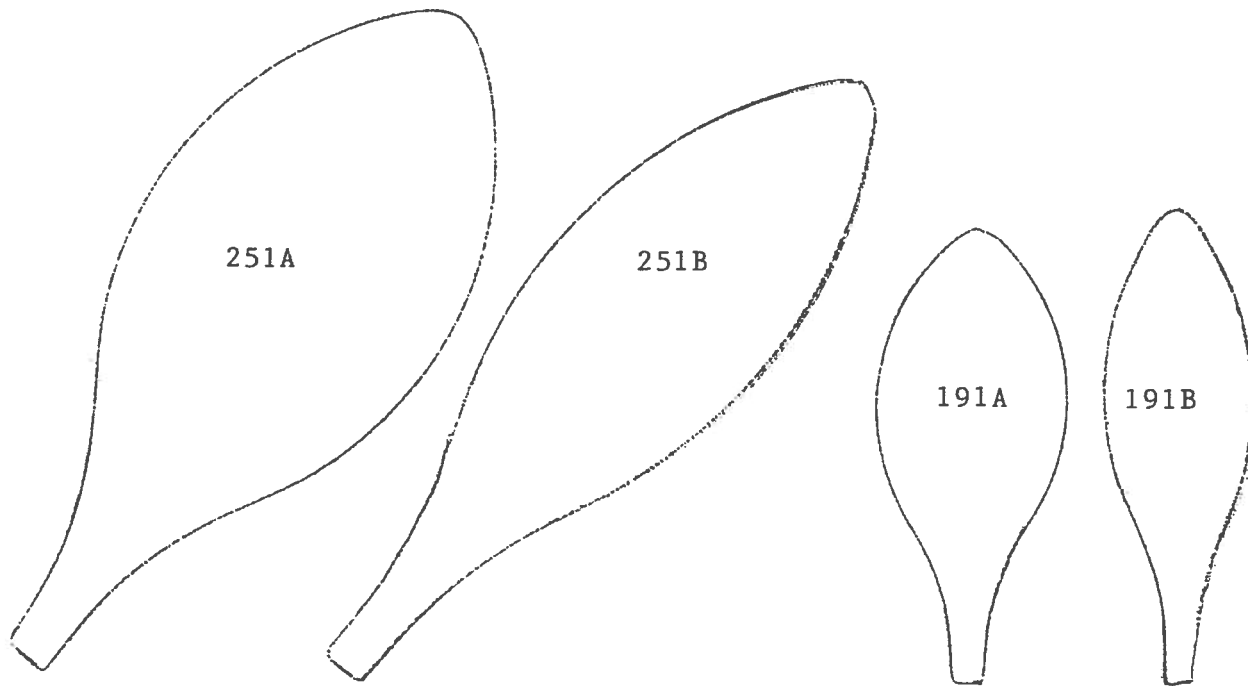

LONGIFLORUM LILY

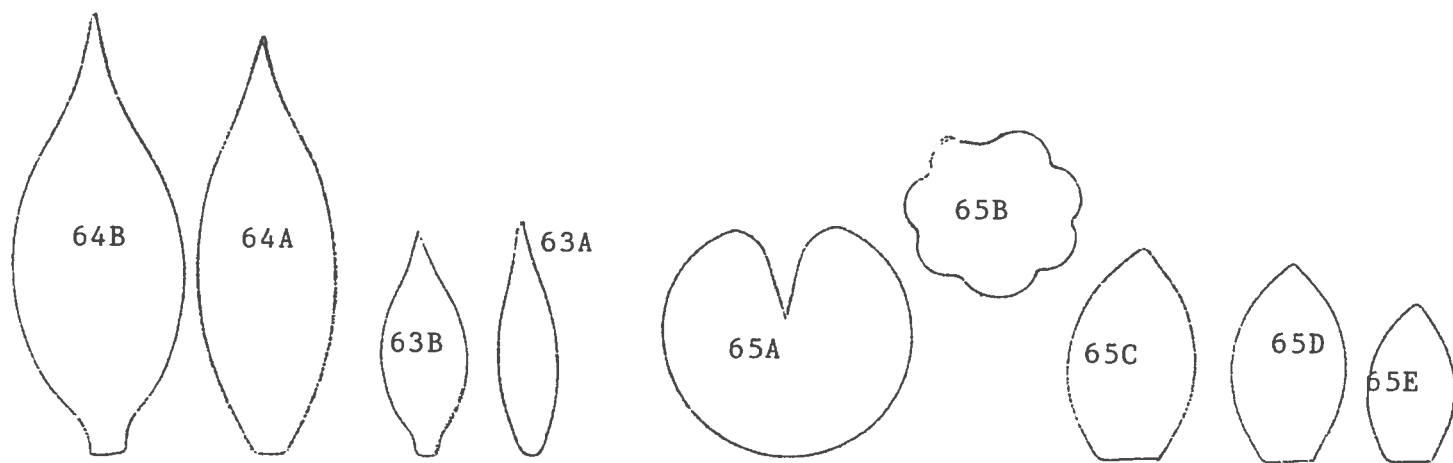

TIGER LILY

TIGER LILY

WATER LILY



WATER LILY

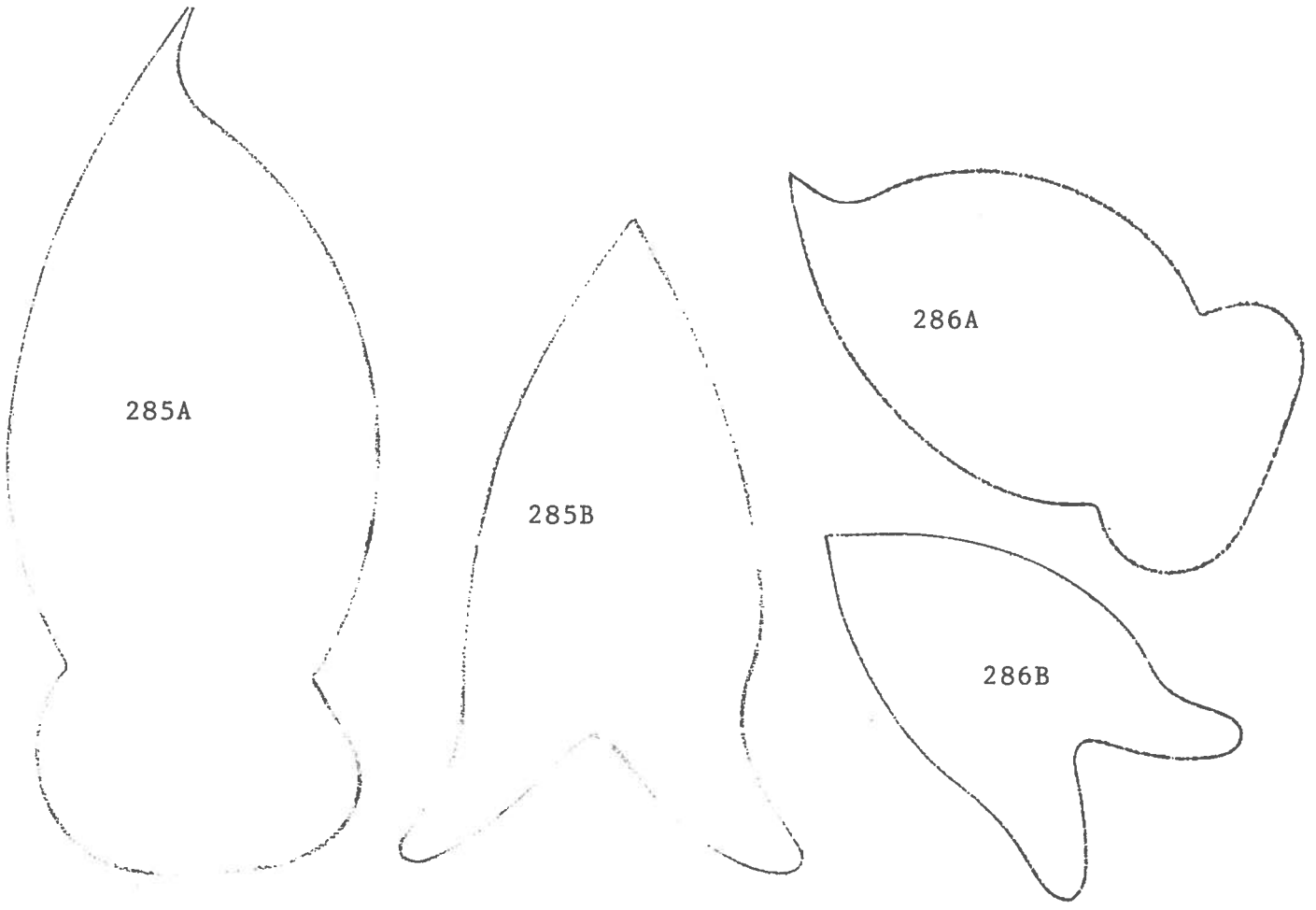
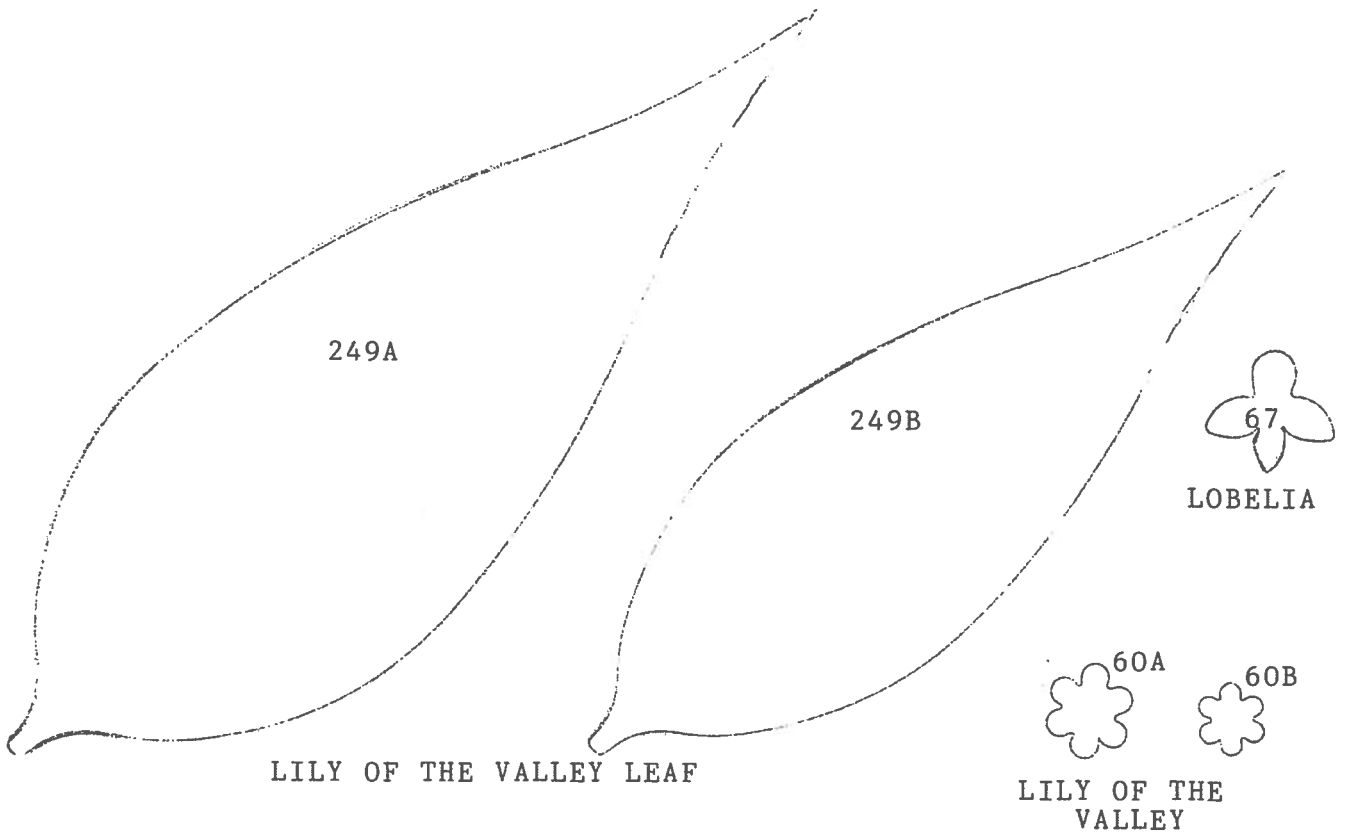

LORDS AND LADIES

LORDS AND LADIES

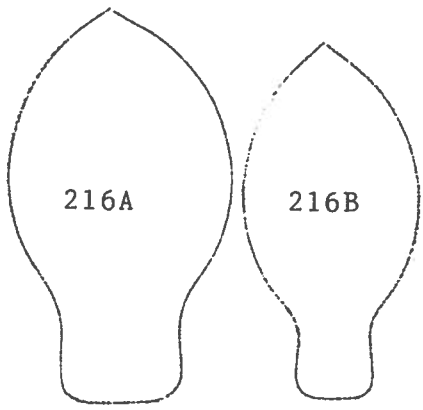

LORDS AND LADIES

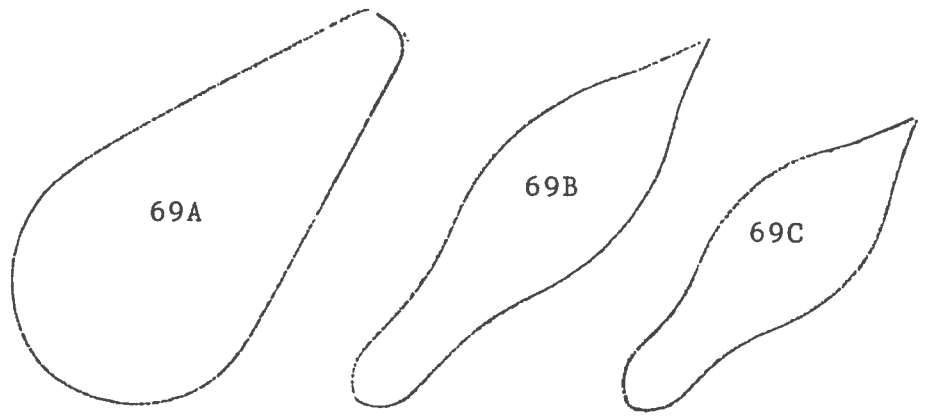

MAGNOLIA

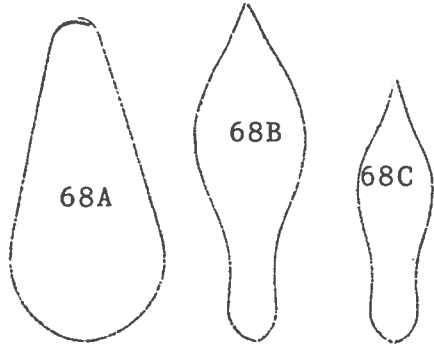

MAGNOLIA



MAPLE LEAF

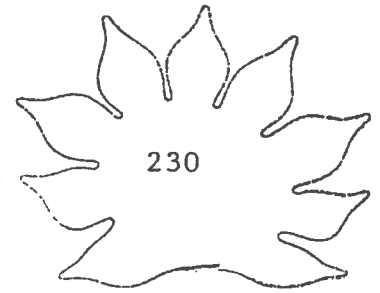

MAPLE LEAF

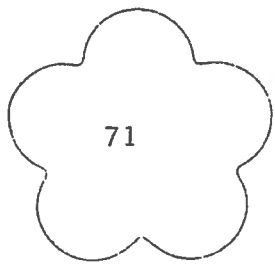

MIRABILIS

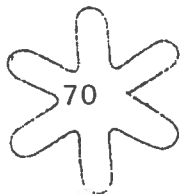

MONTBRETIA



MOON

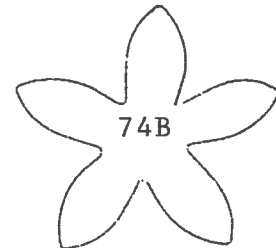

NASTURTIUM

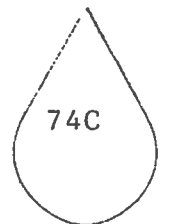

NEMESIA

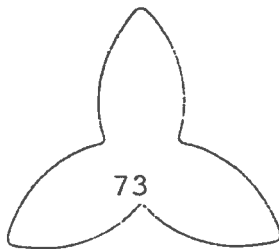

NERINE



OAK
LEAF

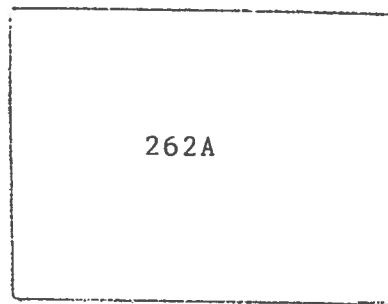

OBLONG

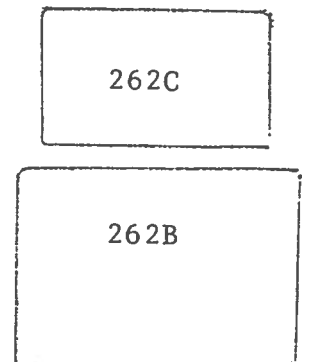

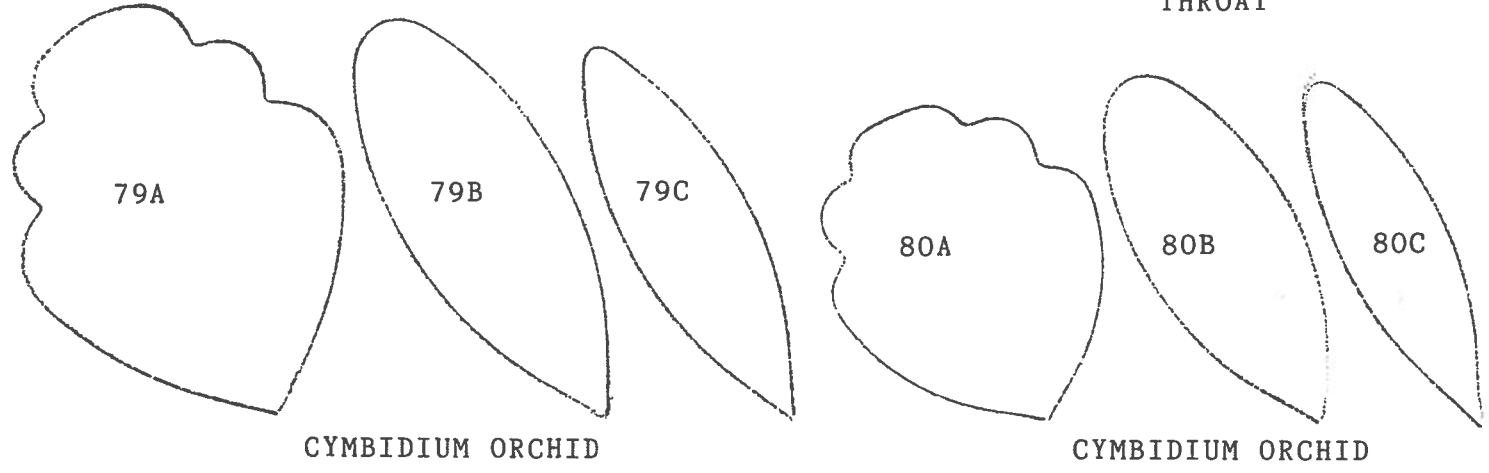
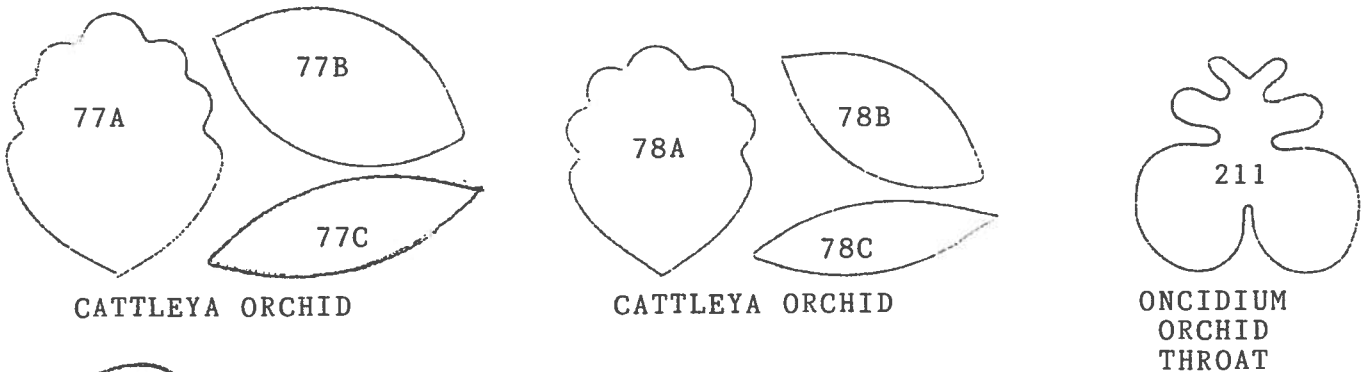
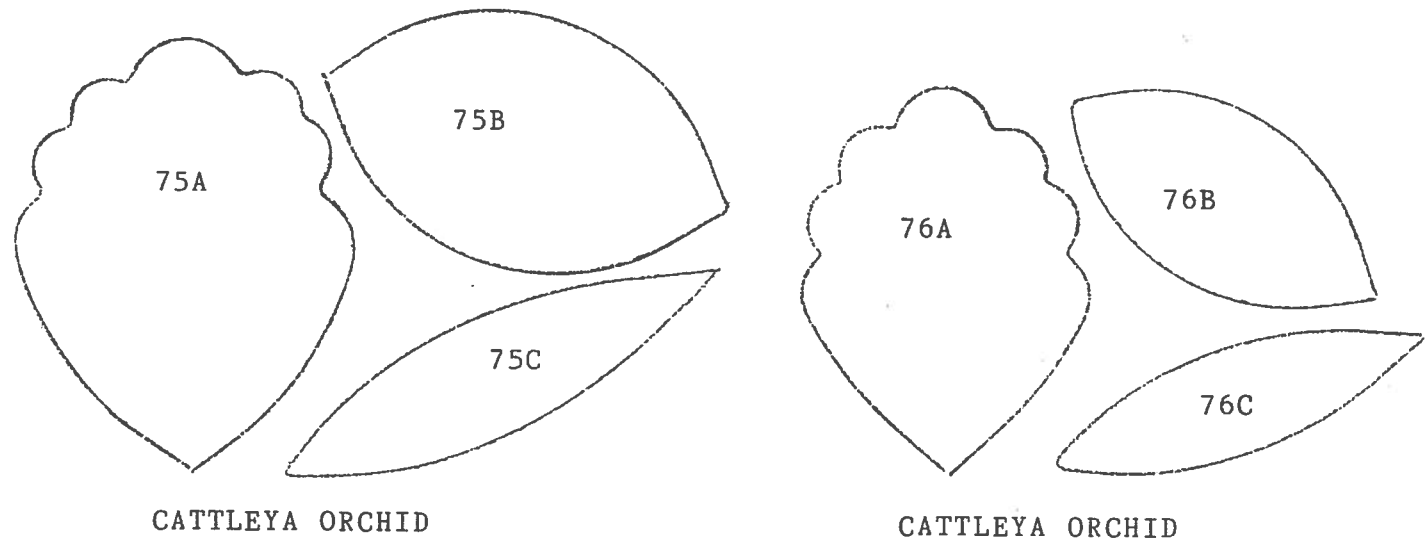
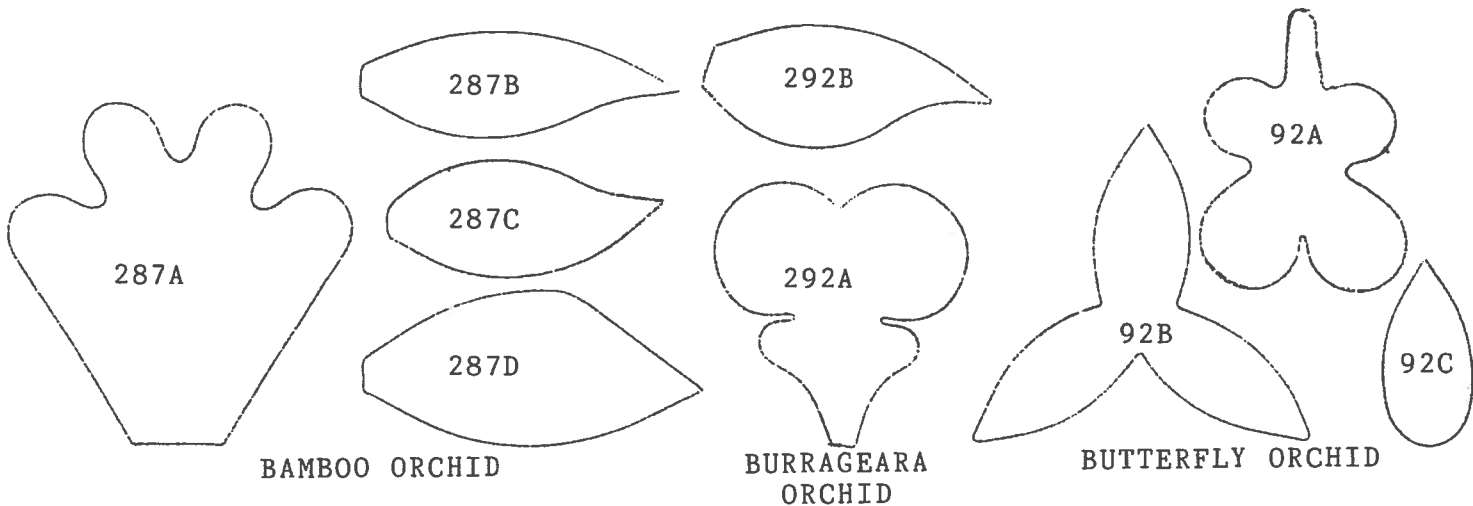

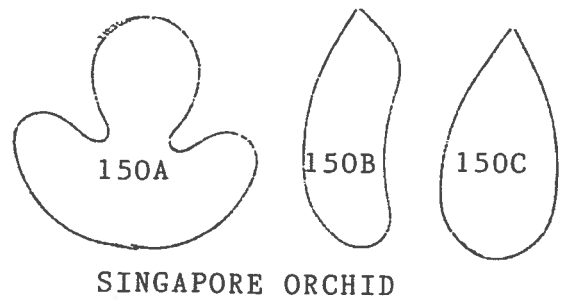
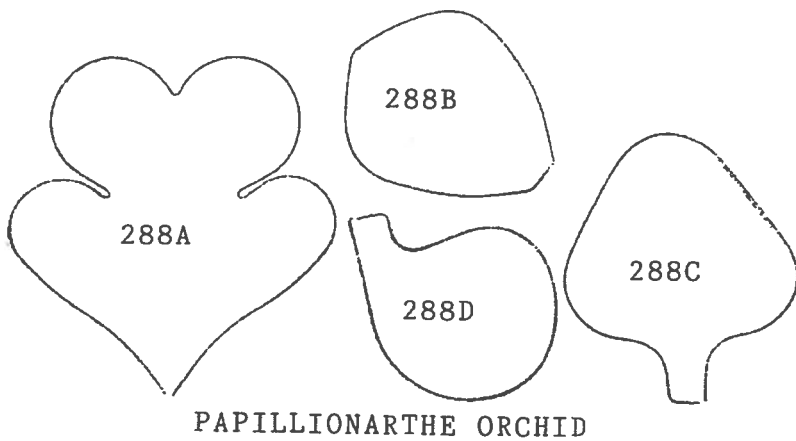
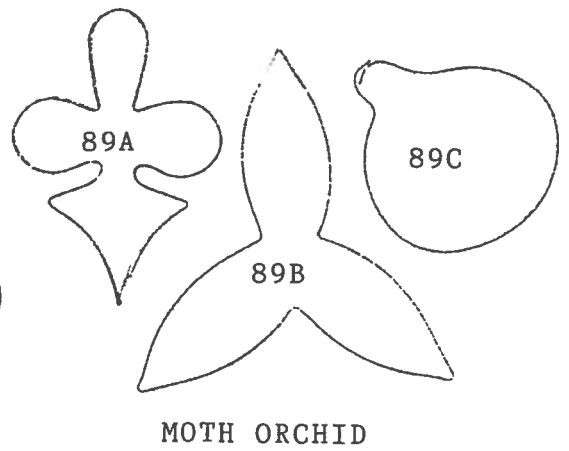
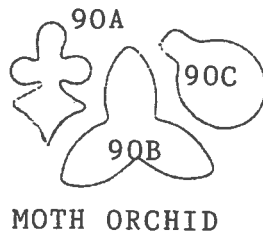
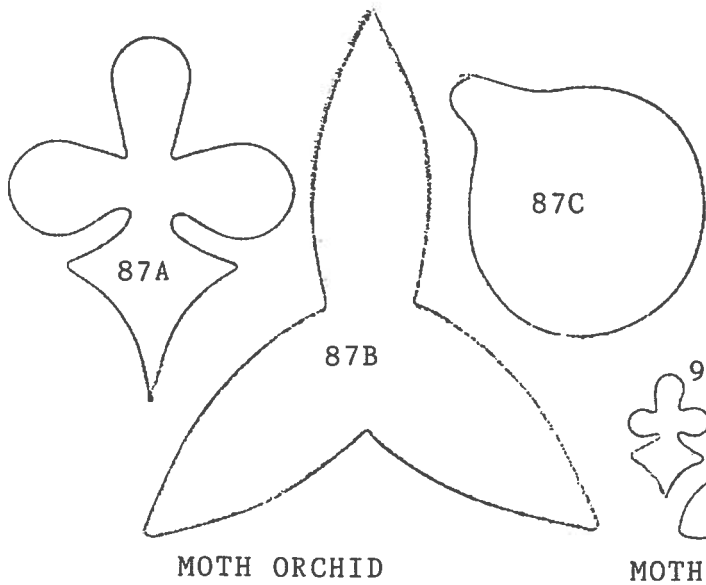
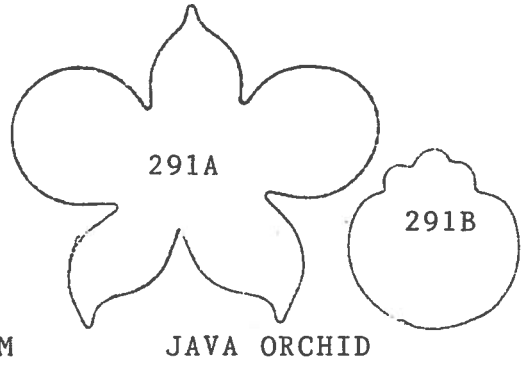
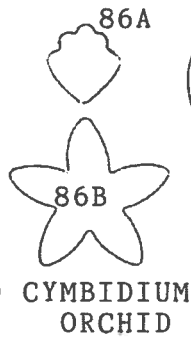
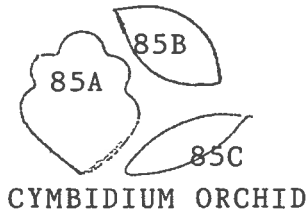
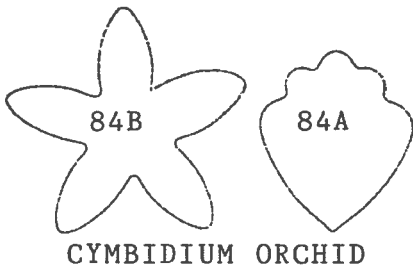
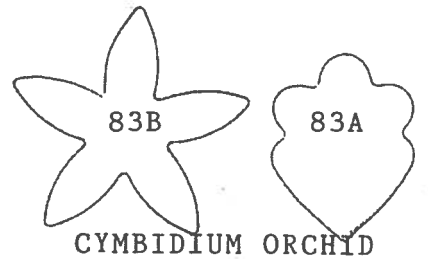
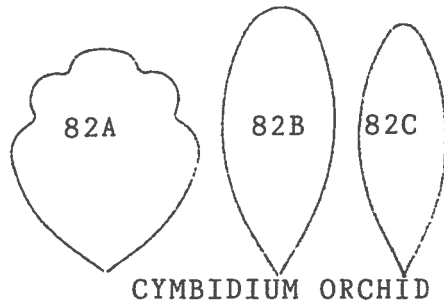
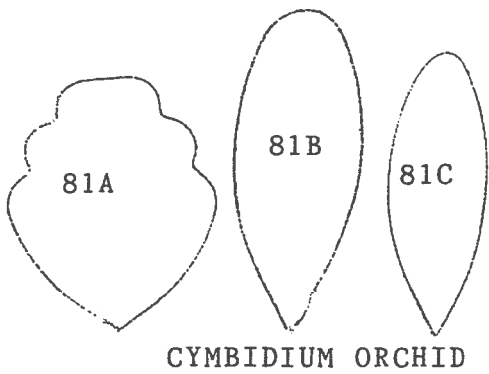

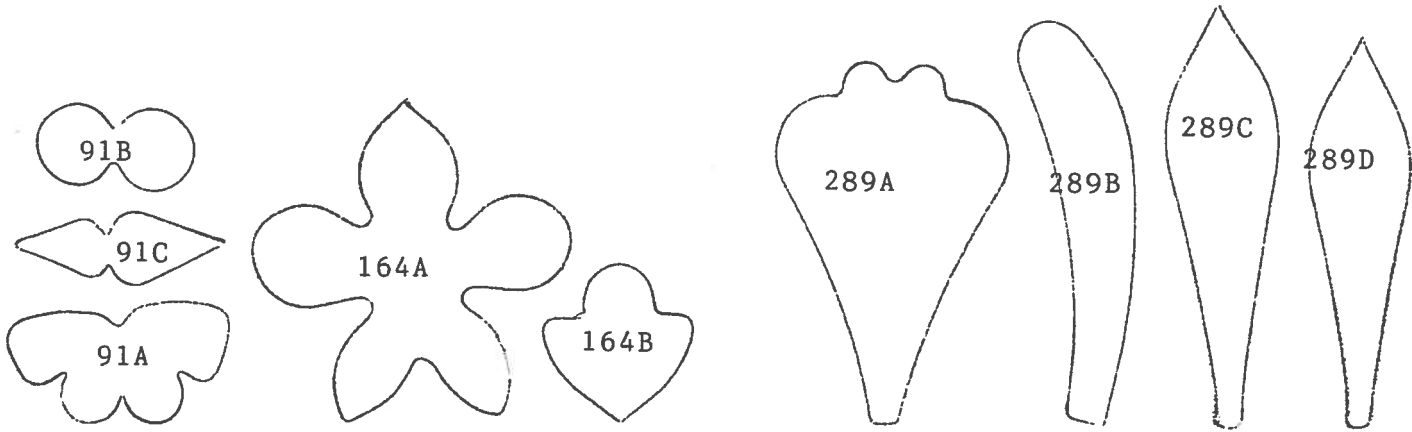

SLIPPER ORCHID

COOKTOWN ORCHID

VANILLA ORCHID

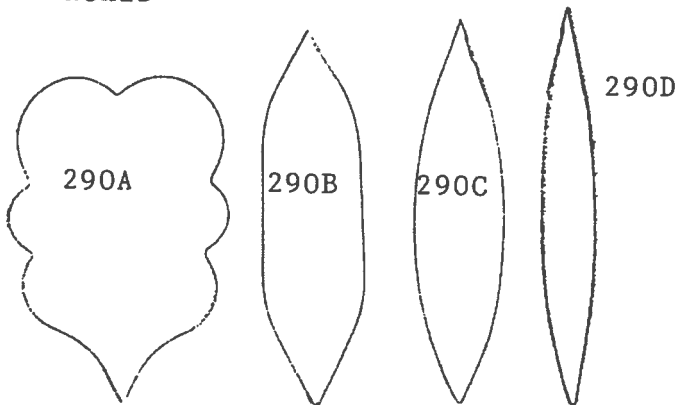

VUYLSTEKEARA ORCHID

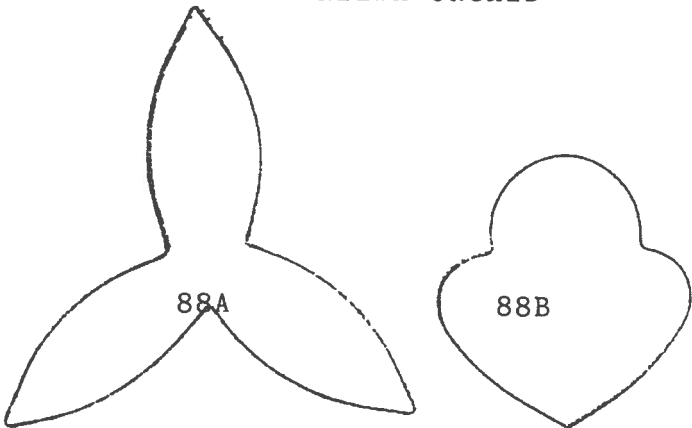

ORCHID PETAL

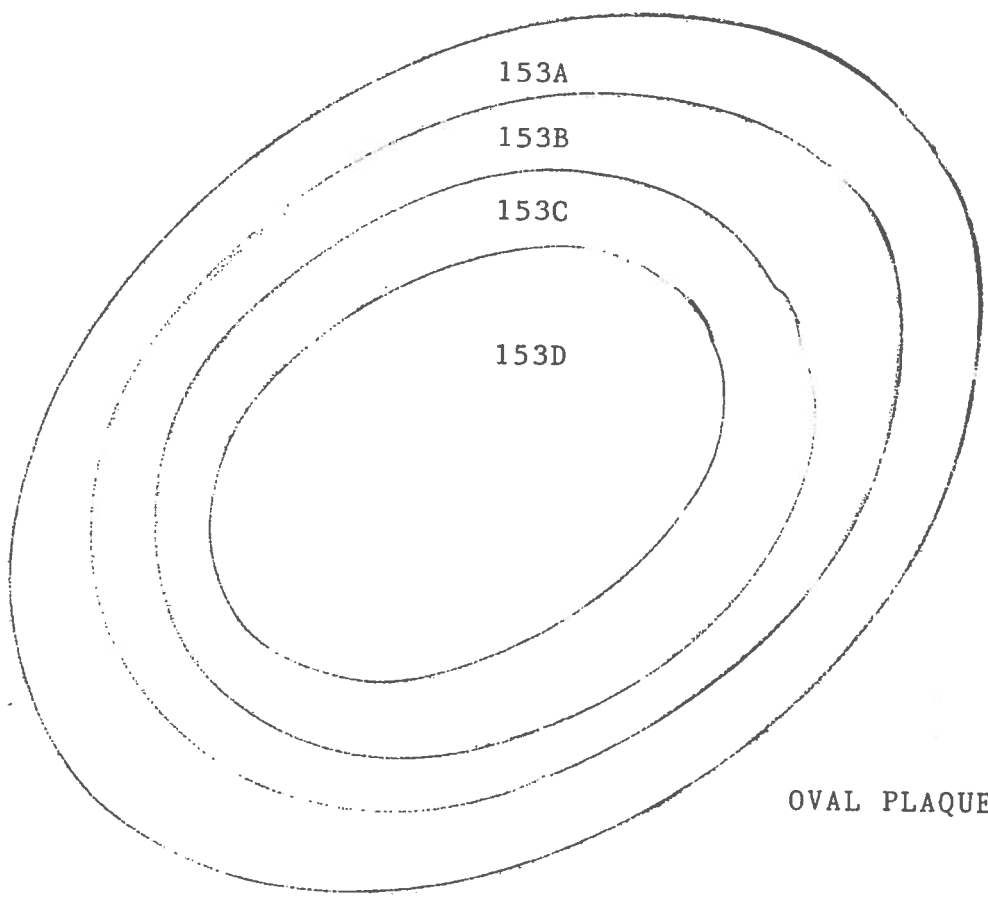

OVAL PLAQUE

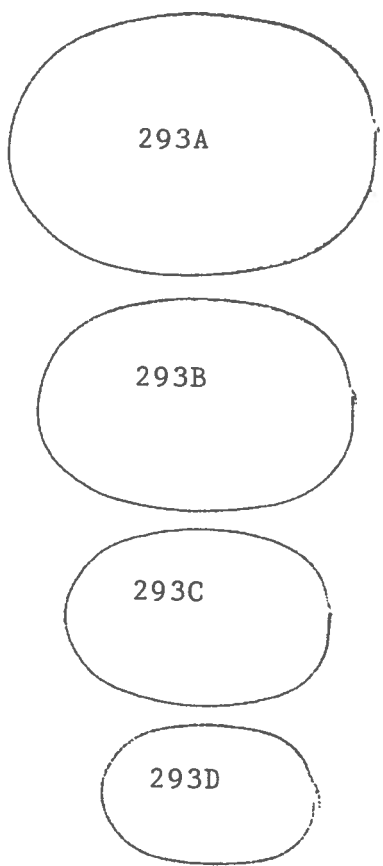

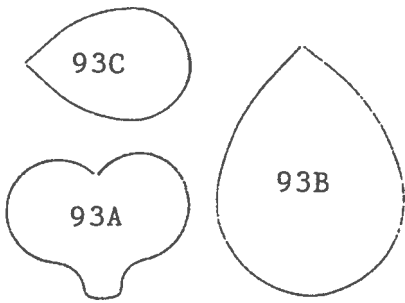

PANSY

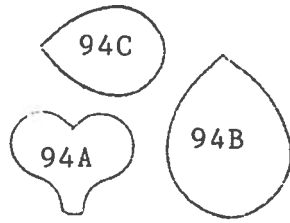

PANSY

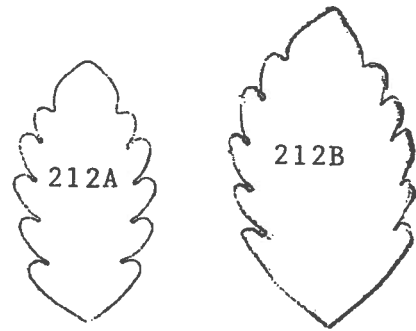

PANSY LEAF

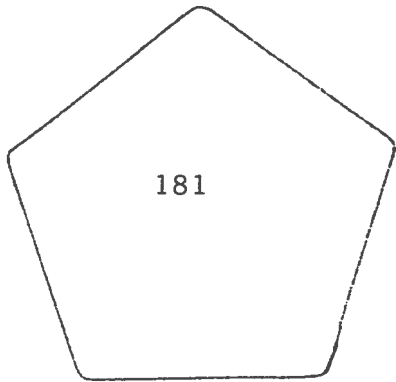

PENTAGON

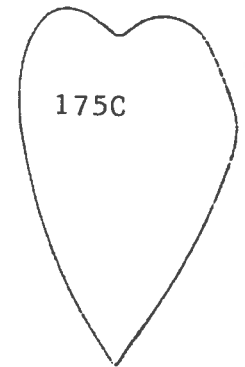
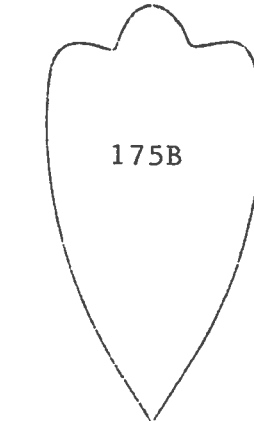
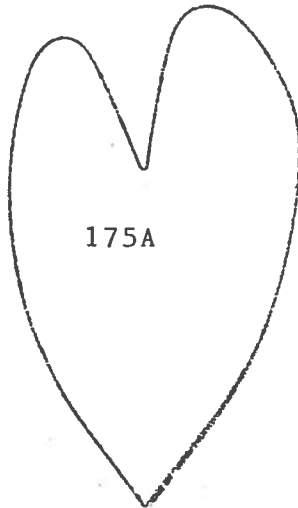

PEONY

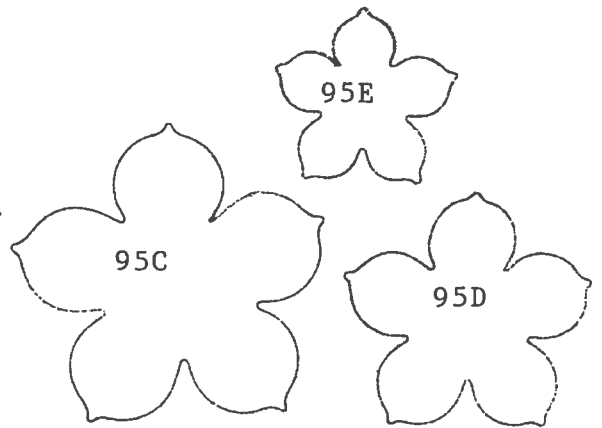
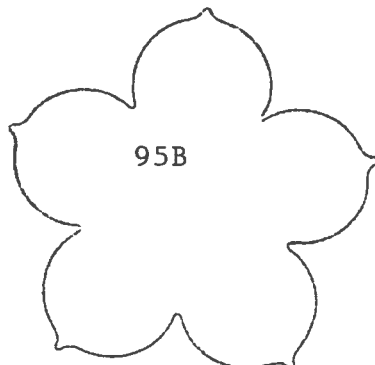
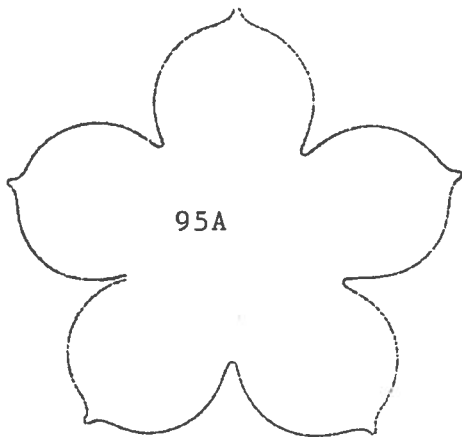

PETUNIA

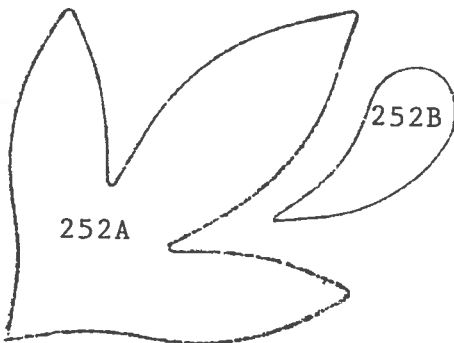

TREE PEONY LEAF

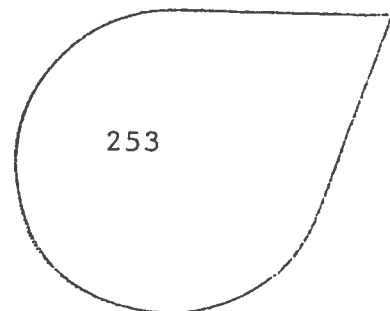

TREE PEONY PETAL

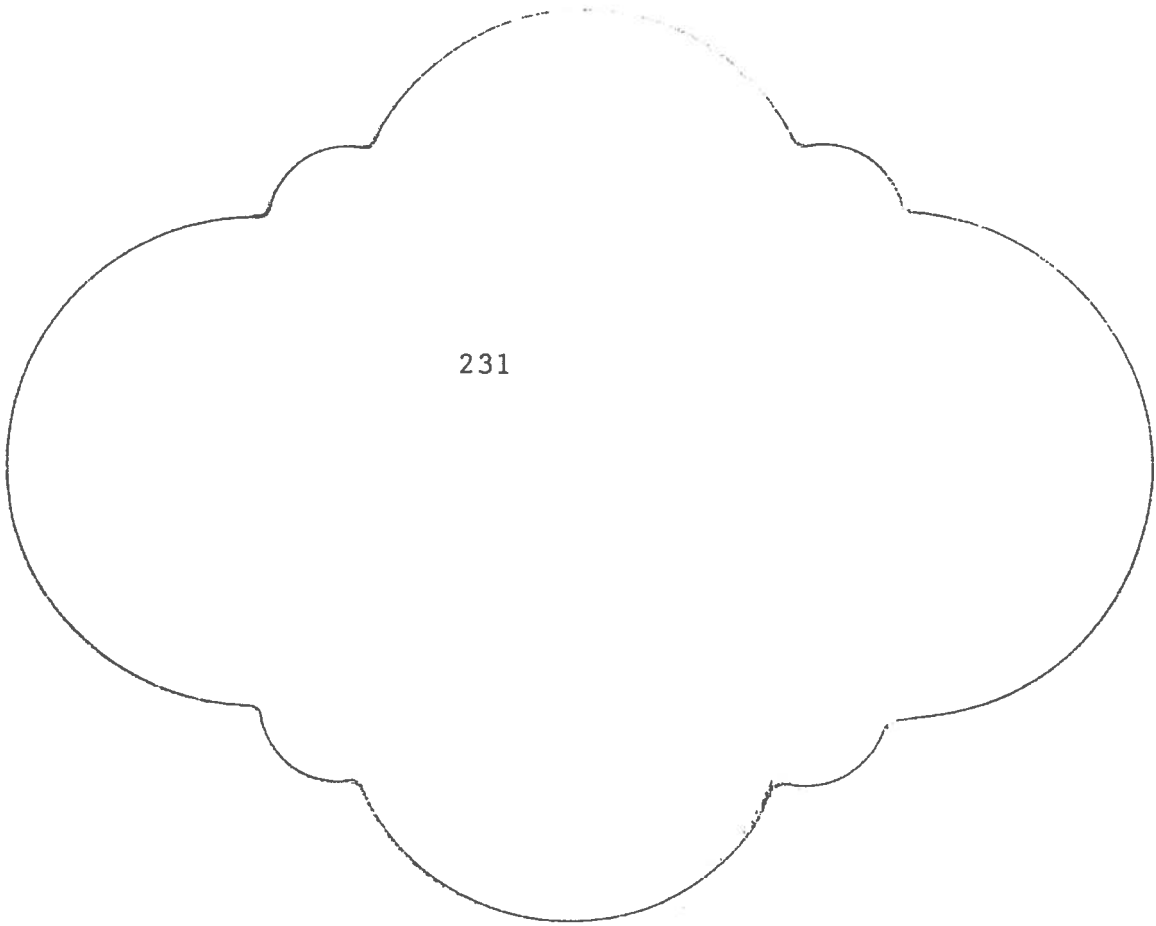

231

PLAQUE

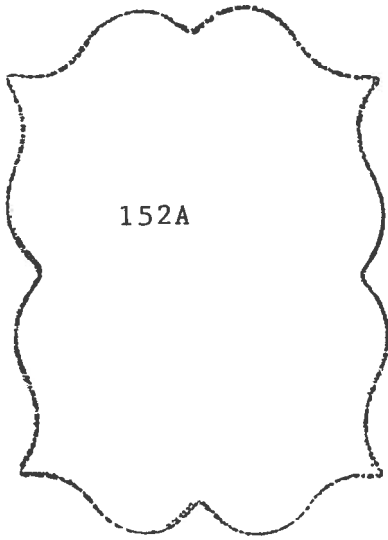

152A

PLAQUE

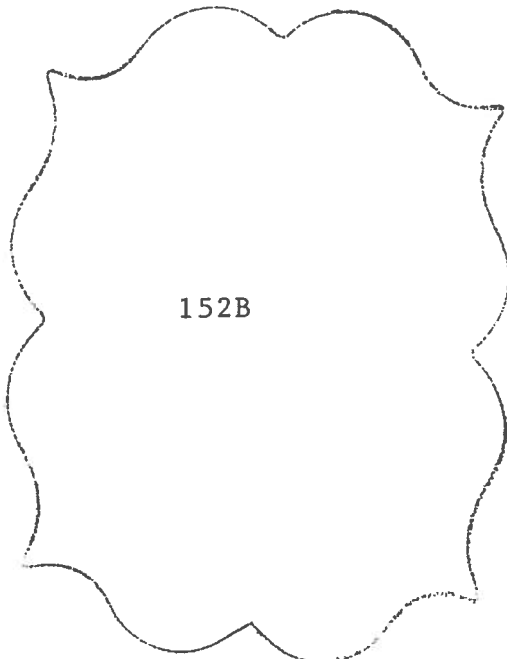

152B

PLAQUE

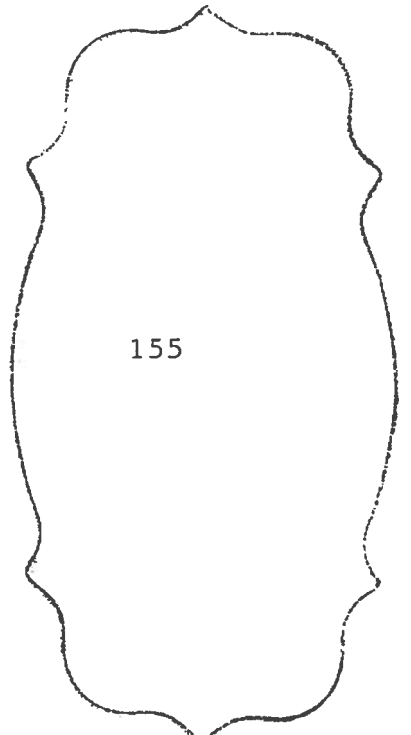

155

PLAQUE

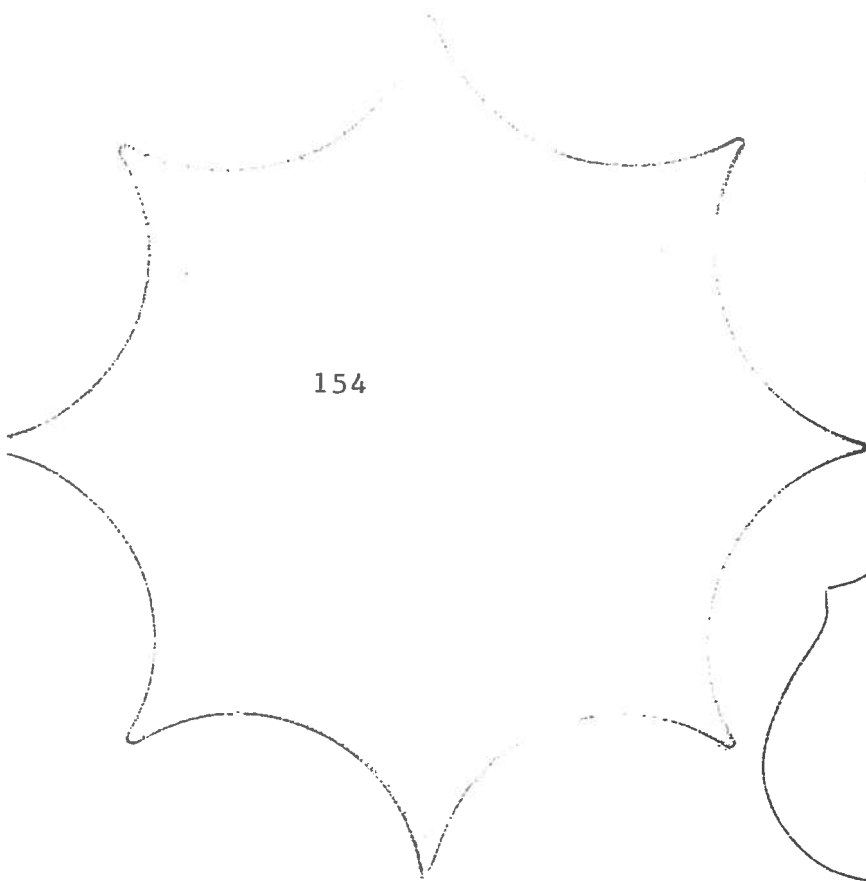

154

PLAQUE

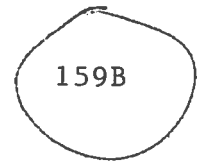
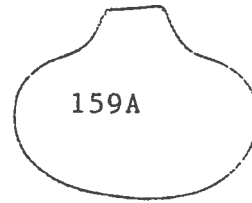

159A

159B

WILD POPPY

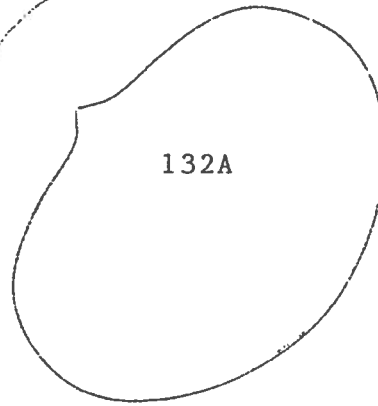

132A

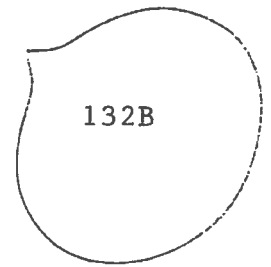

132B

POPPY



255A



255B

POPPY LEAF

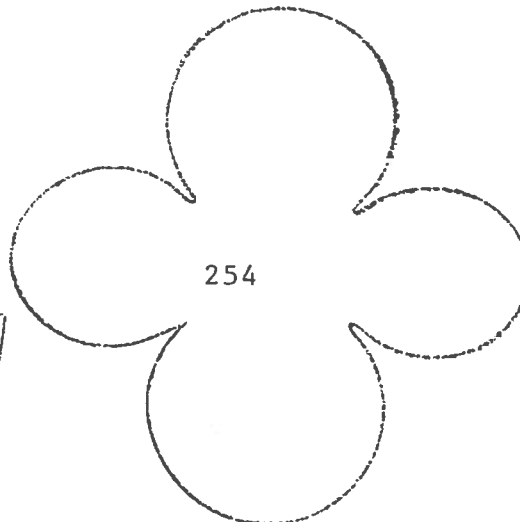

254

ALL-IN-ONE-POPPY

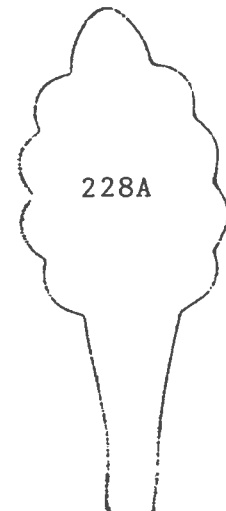

228A



228B

PRIMROSE LEAF

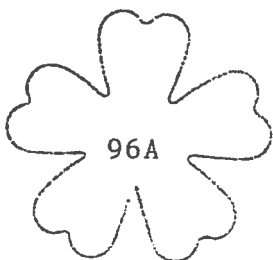

96A



96B

PRIMROSE



96C



96D

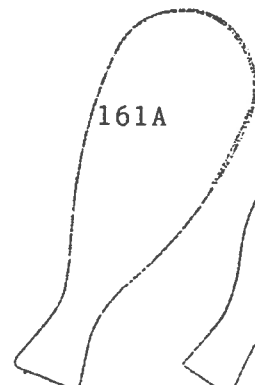

161A

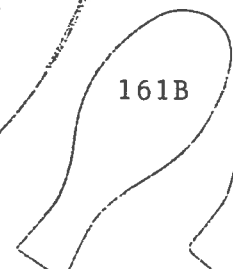

161B

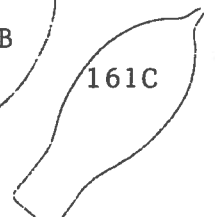

161C

PRIMROSE LEAF

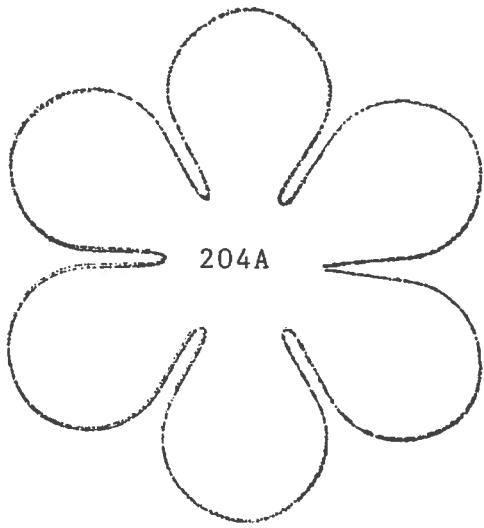

204A

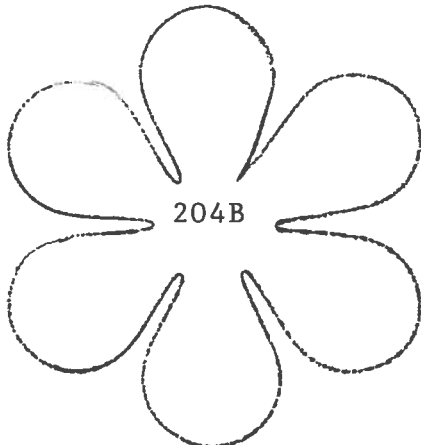

204B

QUICK ROSE

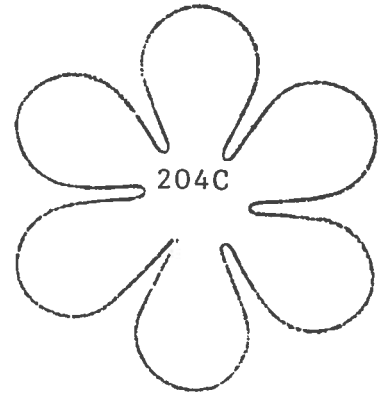

204C

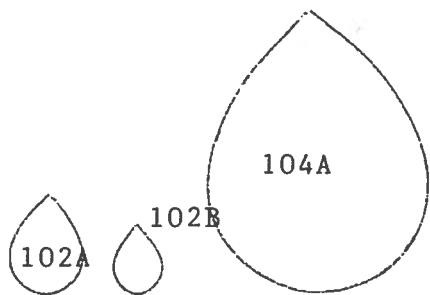

102A

ROSE PETAL

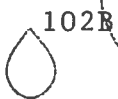

102B

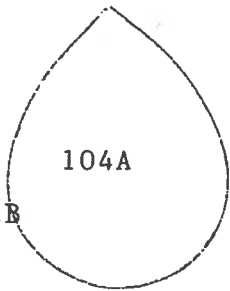

104A

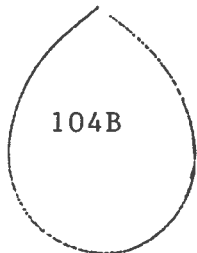

104B

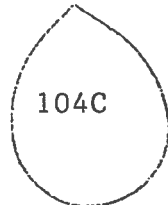

104C

ROSE PETAL

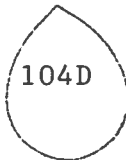

104D



104E

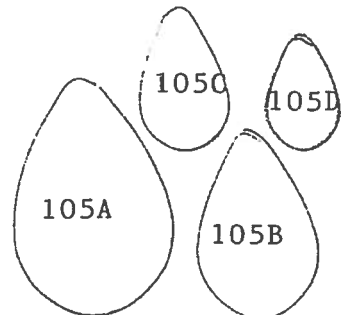

105A

ROSE PETAL

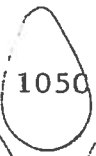

105C



105D

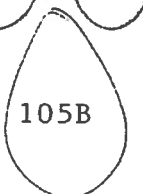

105B

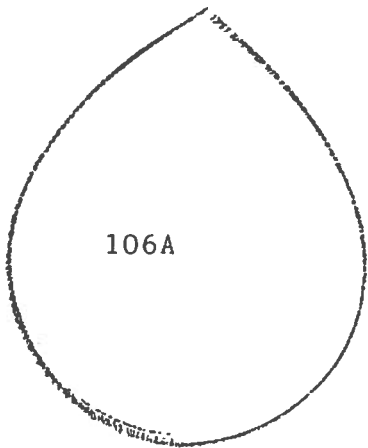

106A

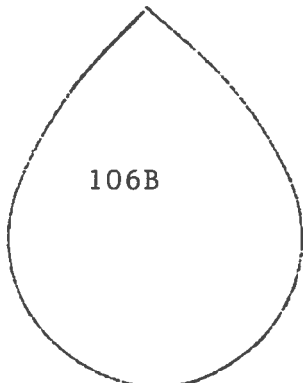

106B

ROSE PETAL

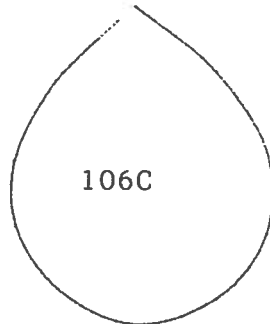

106C

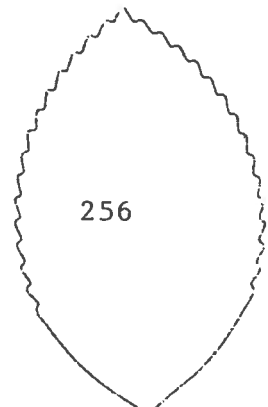

256

LARGE
ROSE
LEAF

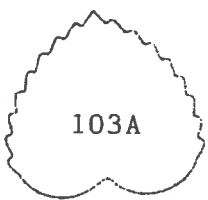

103A



103B

ROSE LEAF



103C

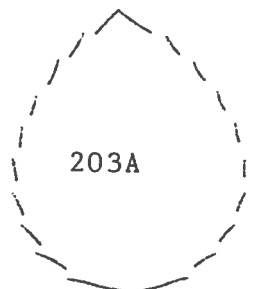

203A

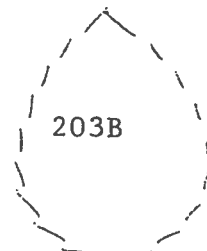

203B

SERRATED ROSE LEAF

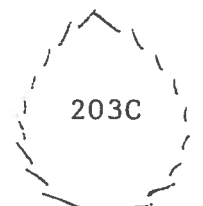

203C

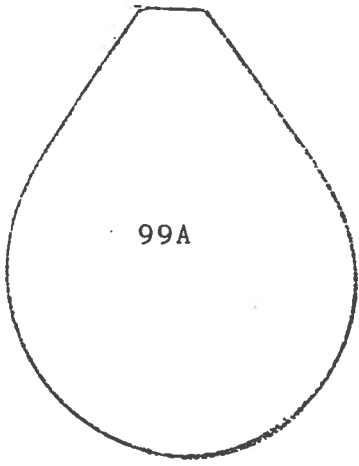

99A

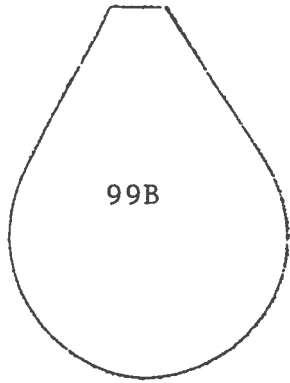

99B

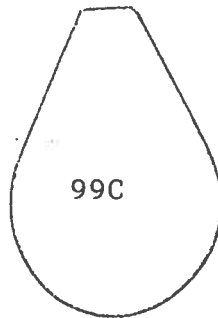

99C

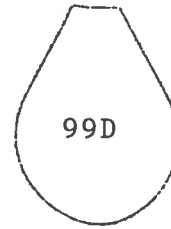

99D

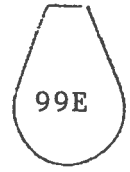

99E

DOG ROSE

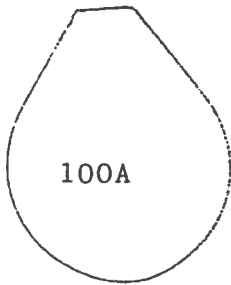

100A

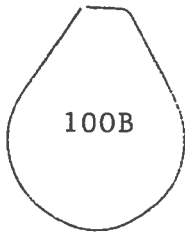

100B

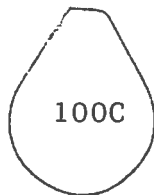

100C



100D



100E

DOG ROSE

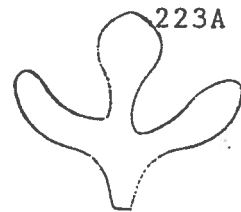

223A



223B

RUE

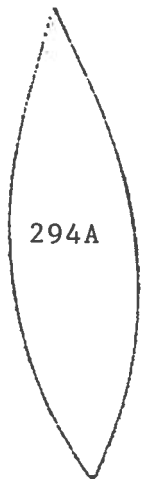

294A



294B



294C



294D



294E

RUSCUS

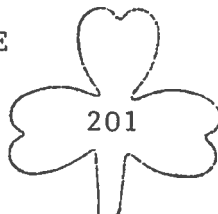

201

SHAMROCK

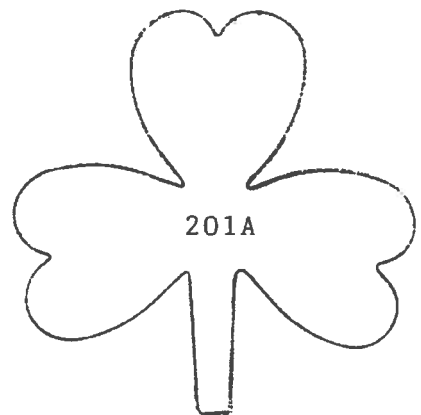

201A

SHAMROCK

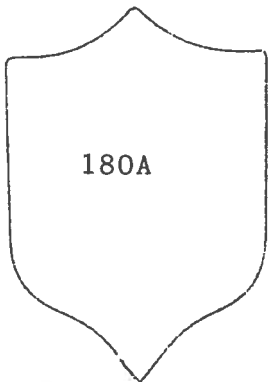

180A

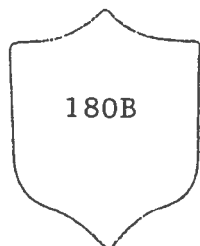

180B

SHIELD

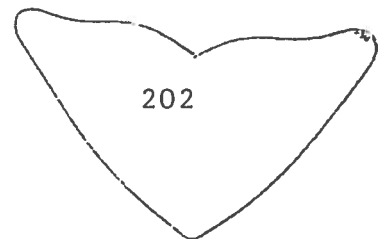

202

SHAMROCK
LEAF

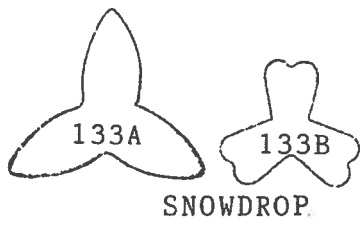

SNOWDROP

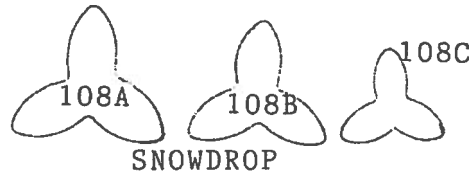

SNOWDROP

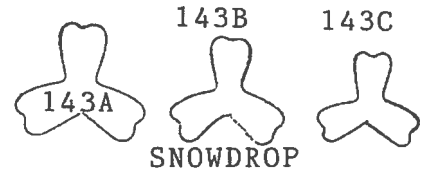

SNOWDROP

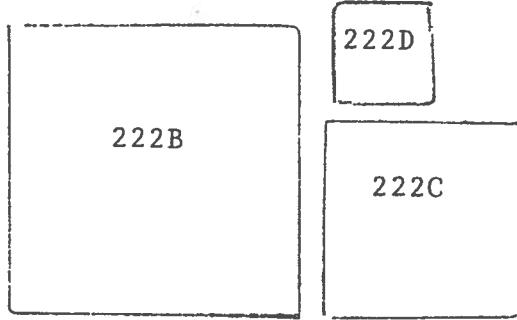
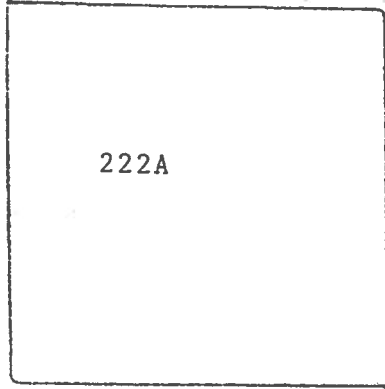

SQUARE

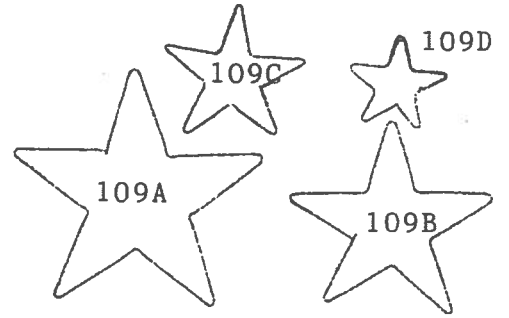

STAR CALYX

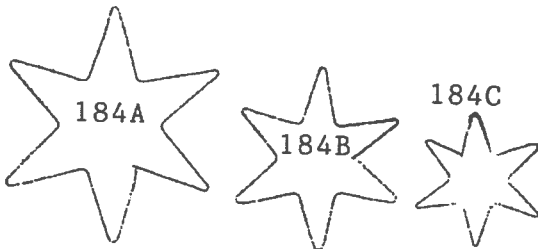

SIX POINTED STAR

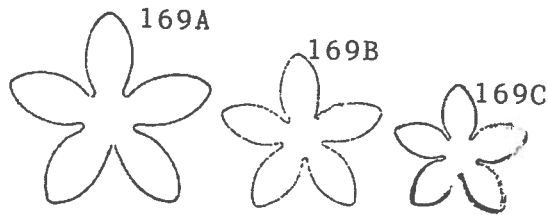

STEPHANOTIS

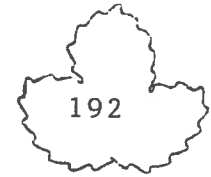

STRAWBERRY LEAF

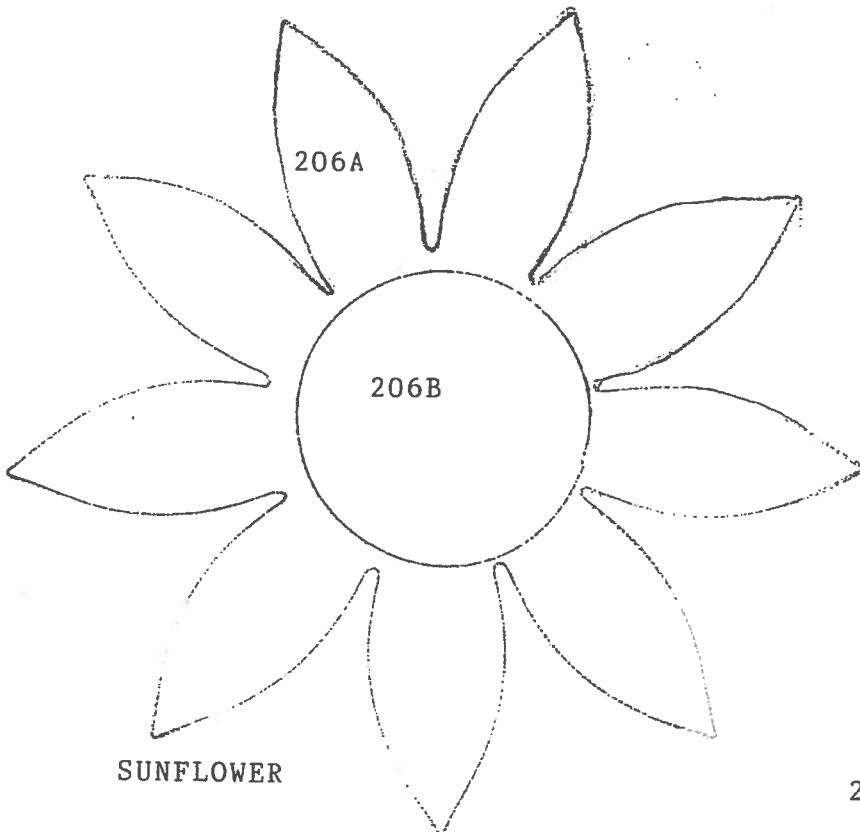

SUNFLOWER



SUNFLOWER

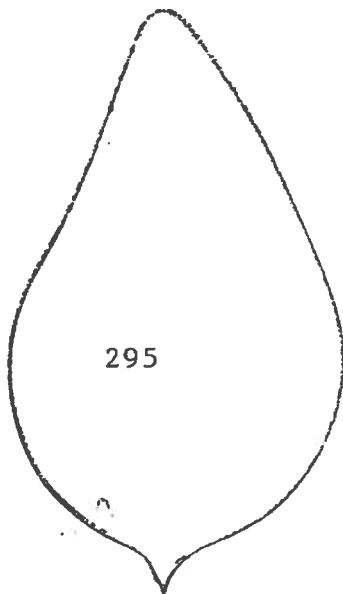

SUNFLOWER LEAF

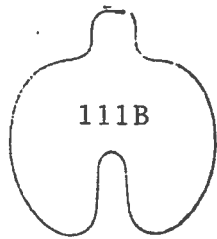

SWEET PEA

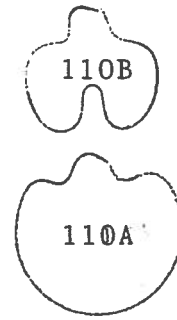
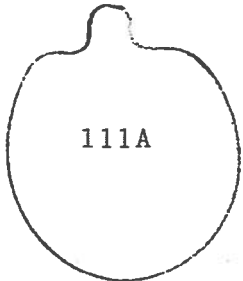

SWEET PEA

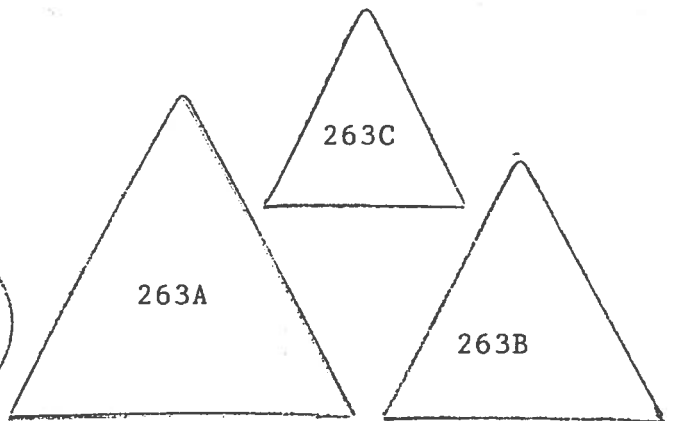

TRIANGLE

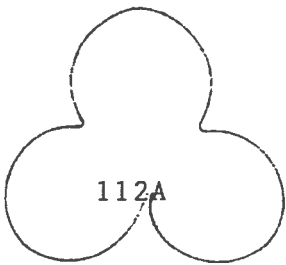
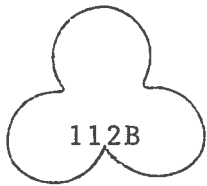

TULIP

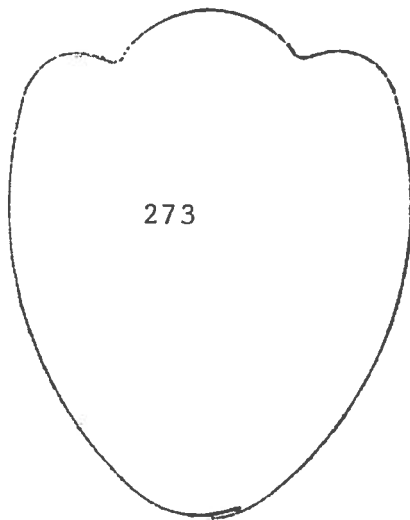

TULIP

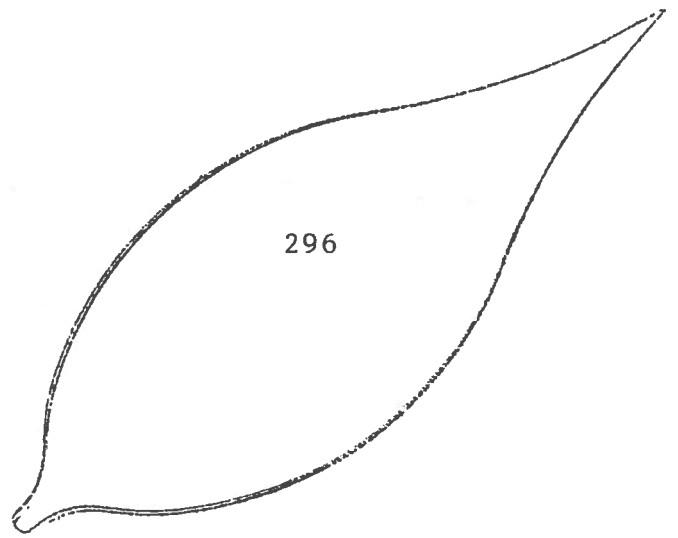

TULIP LEAF

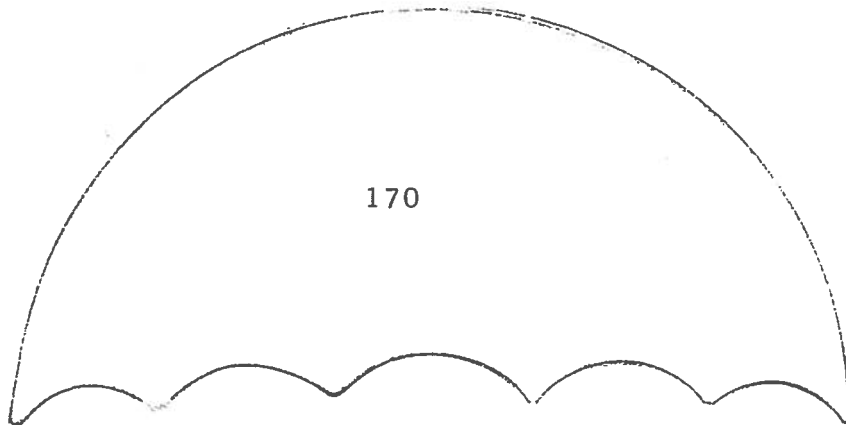

UMBRELLA

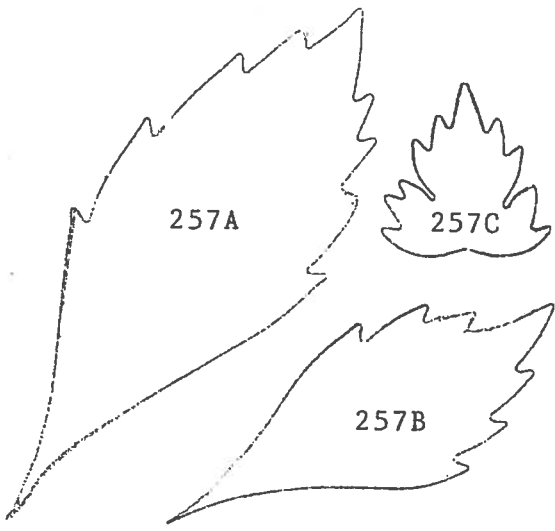

VIRGINIA CREEPER

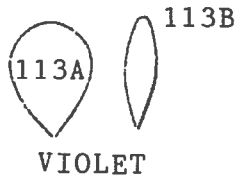

VIOLET



VIOLET

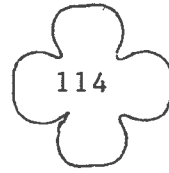

WALLFLOWER

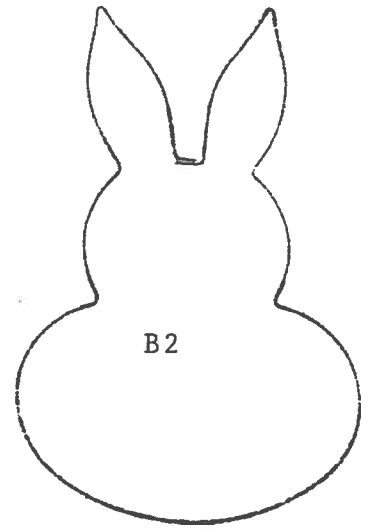

BUNNY

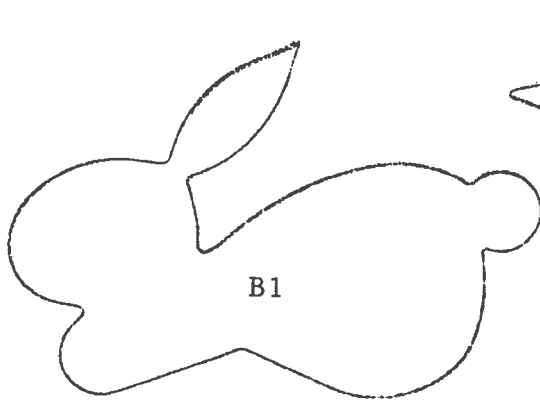

BUNNY

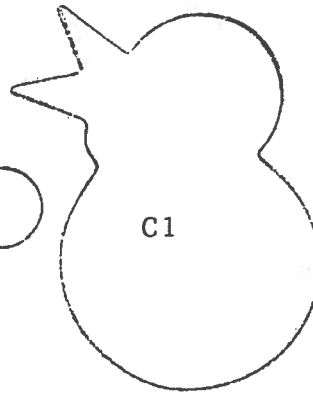

CHICK

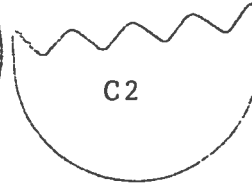

EGG SHELL

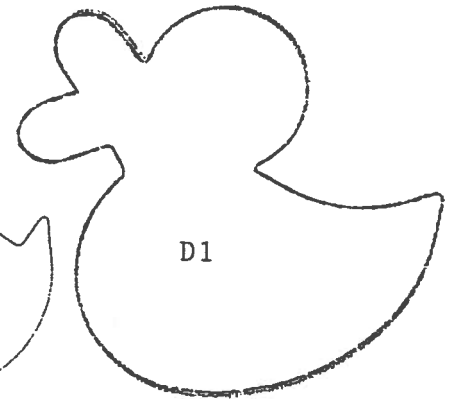

DUCK

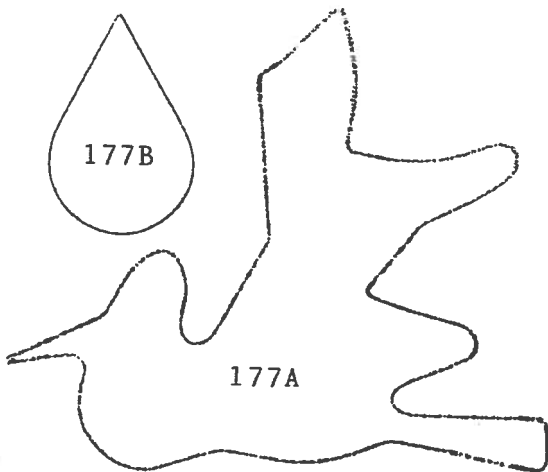

STORK

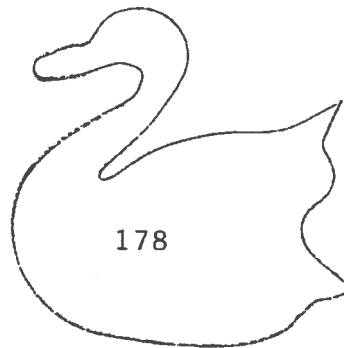

SWAN

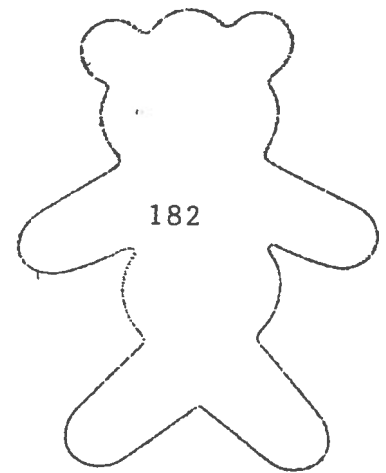

TEDDY

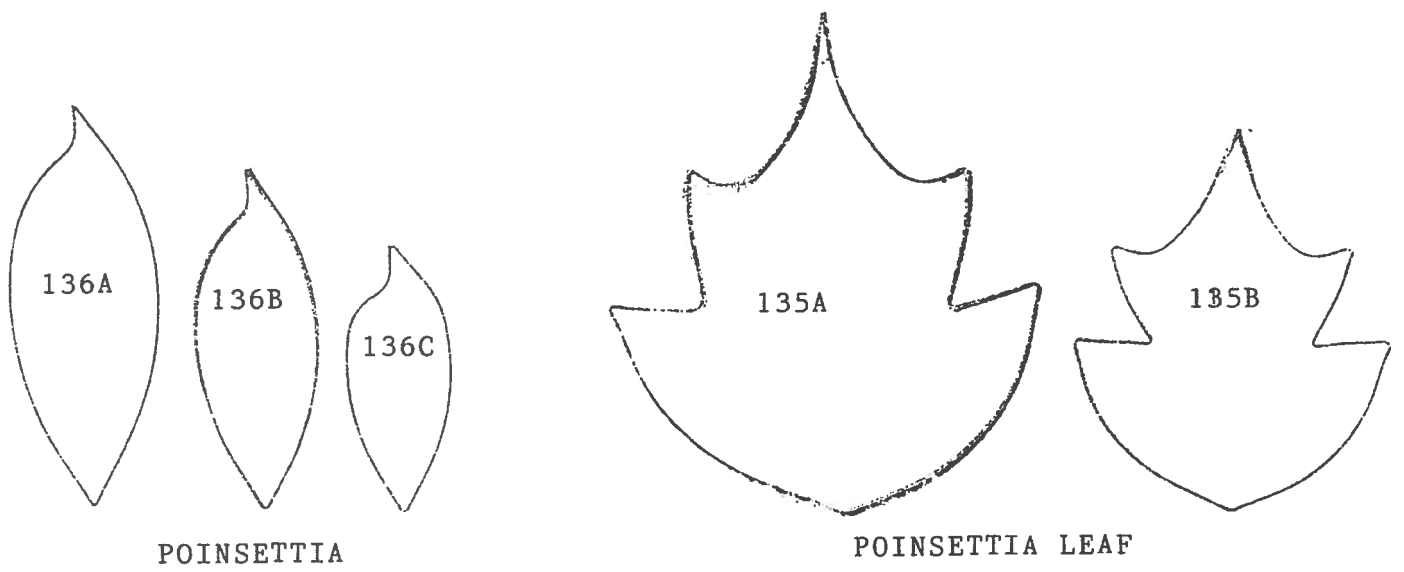
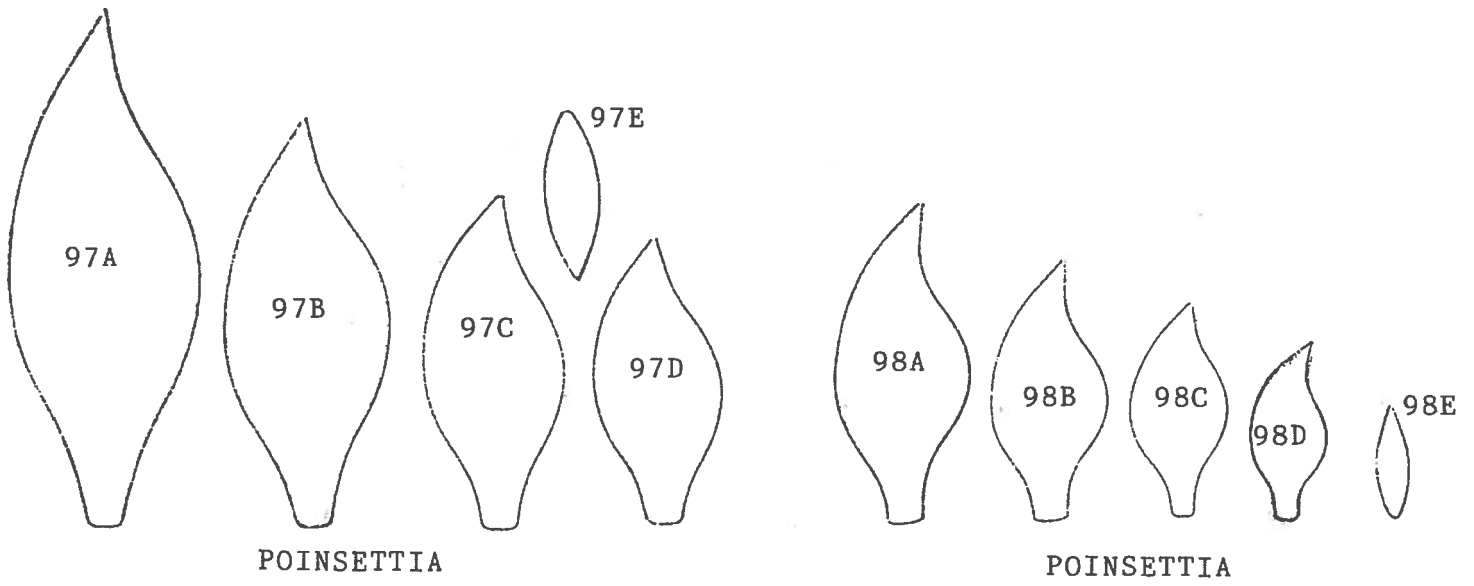
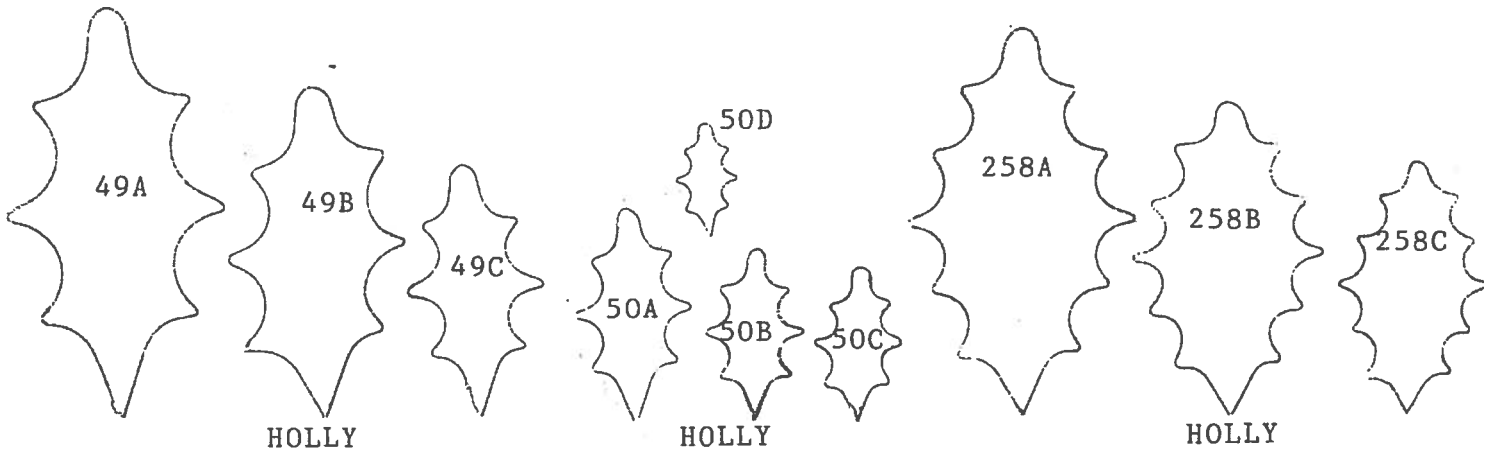

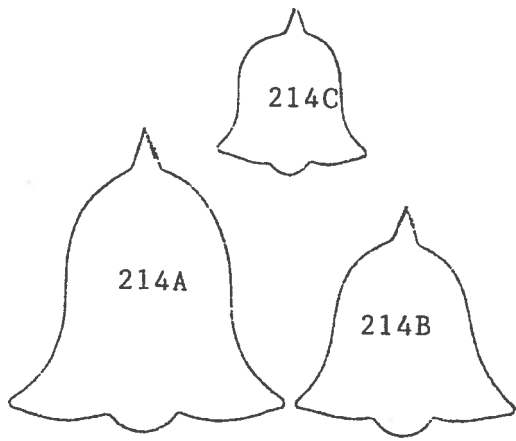

CHRISTMAS BELL

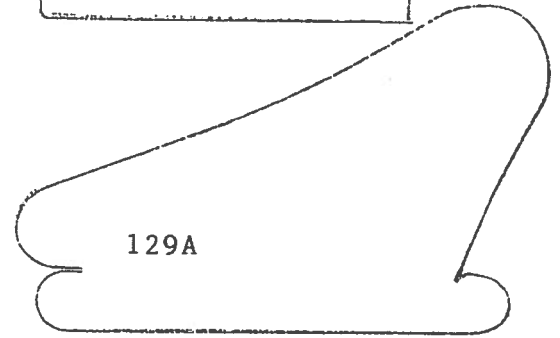
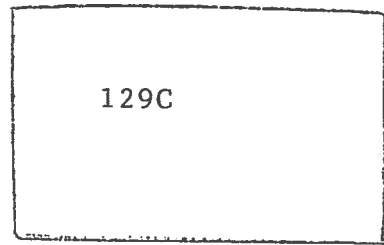
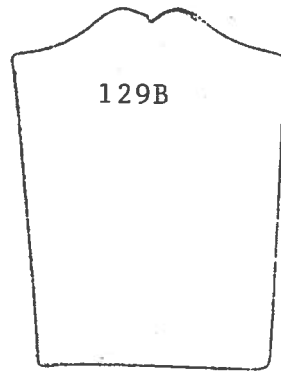
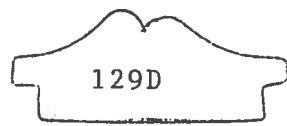

SLEIGH

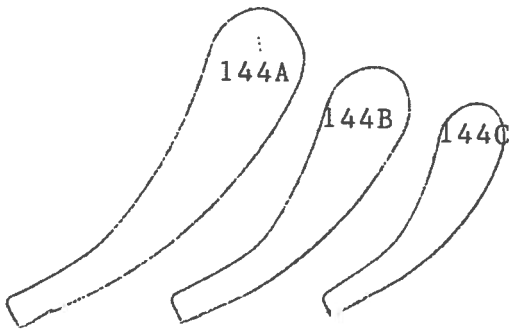

MISTLETOE

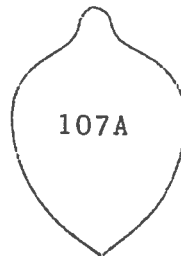

CHRISTMAS ROSE



ROBIN

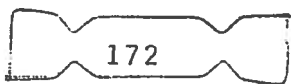

CHRISTMAS
CRACKER

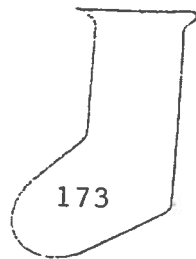

CHRISTMAS
STOCKING

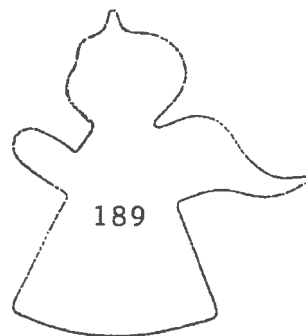

ANGEL

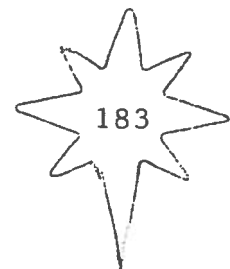

CHRISTMAS
STAR



119A



119B



119C

CHRISTMAS TREE

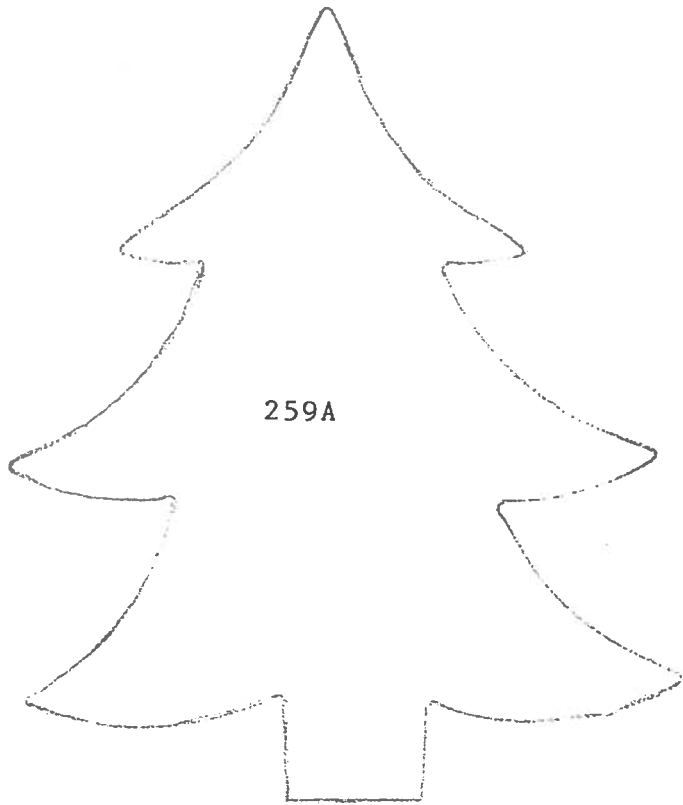

259A



259B

CHRISTMAS TREE

